



Simply Better Connections

VW1608 / VW3620

Modular Video Wall Processor
User Manual

Compliance Statements

FEDERAL COMMUNICATIONS COMMISSION INTERFERENCE STATEMENT

This equipment has been tested and found to comply with the limits for a Class A digital device, pursuant to Part 15 of the FCC Rules. These limits are designed to provide reasonable protection against harmful interference when the equipment is operated in a commercial environment. This equipment generates, uses, and can radiate radio frequency energy and, if not installed and used in accordance with the instruction manual, may cause harmful interference to radio communications. Operation of this equipment in a residential area is likely to cause harmful interference in which case the user will be required to correct the interference at his own expense.

The device complies with Part 15 of the FCC Rules. Operation is subject to the following two conditions: (1) this device may not cause harmful interference, and (2) this device must accept any interference received, including interference that may cause undesired operation.

FCC Caution

Any changes or modifications not expressly approved by the party responsible for compliance could void the user's authority to operate this equipment.

Warning

Operation of this equipment in a residential environment could cause radio interference.

Achtung

Der Gebrauch dieses Geräts in Wohnumgebung kann Funkstörungen verursachen.



KCC Statement

유선 제품용 / A 급 기기 (업무용 방송 통신 기기)
이 기기는 업무용 (A 급) 전자파적합기기로서 판매자 또는 사용자는 이
점을 주의하시기 바라며, 가정 외의 지역에서 사용하는 것을 목적으로
합니다.

Industry Canada Statement

This Class A digital apparatus complies with Canadian ICES-003.

CAN ICES-003 (A) / NMB-003 (A)



Trademark Notice: The terms HDMI, HDMI High-Definition Multimedia Interface, HDMI trade dress and the HDMI Logos are trademarks or registered trademarks of HDMI Licensing Administrator, Inc.

RoHS

This product is RoHS compliant.

User Information

Online Registration

Be sure to register your product at our online support center:

| | |
|---------------|---|
| International | http://eservice.aten.com |
|---------------|---|

Telephone Support

For telephone support, call this number:

| | |
|---------------|---|
| International | 886-2-8692-6959 |
| China | 86-400-810-0-810 |
| Japan | 81-3-5615-5811 |
| Korea | 82-2-467-6789 |
| North America | 1-888-999-ATEN ext 4988 1-949-428-1111 |

User Notice

All information, documentation, and specifications contained in this manual are subject to change without prior notification by the manufacturer. The manufacturer makes no representations or warranties, either expressed or implied, with respect to the contents hereof and specifically disclaims any warranties as to merchantability or fitness for any particular purpose. Any of the manufacturer's software described in this manual is sold or licensed *as is*. Should the programs prove defective following their purchase, the buyer (and not the manufacturer, its distributor, or its dealer), assumes the entire cost of all necessary servicing, repair and any incidental or consequential damages resulting from any defect in the software.

The manufacturer of this system is not responsible for any radio and/or TV interference caused by unauthorized modifications to this device. It is the responsibility of the user to correct such interference.

The manufacturer is not responsible for any damage incurred in the operation of this system if the correct operational voltage setting was not selected prior to operation. PLEASE VERIFY THAT THE VOLTAGE SETTING IS CORRECT BEFORE USE.

Caution: There is a risk of explosion if the battery is replaced by an incorrect type. Always dispose of used batteries according to the relevant instructions.

Product Information

For information about all ATEN products and how they can help you connect without limits, visit ATEN on the Web or contact an ATEN Authorized Reseller. Visit ATEN on the Web for a list of locations and telephone numbers:

| | |
|---------------|---|
| International | http://www.aten.com |
|---------------|---|

Package Contents

Check to make sure that all of the components are present and in good order. If anything is missing or was damaged in shipping, contact your dealer.

VW1608

The VW1608 package consists of:

- ◆ 1 VW1608 16× 8 Modular Video Wall Processor
- ◆ 1 power module
- ◆ 1 power cord
- ◆ 1 cable strap
- ◆ 1 user instructions

VW3620

The VW3620 package consists of:

- ◆ 1 VW3620 36 × 20 Modular Video Wall Processor
- ◆ 1 power module
- ◆ 1 power cord
- ◆ 1 cable strap
- ◆ 1 user instructions

VW784 / VW884

The 4-Port 4K HDMI Input Board for VW Series / 4-Port 4K HDMI Output Board for VW Series package consists of:

- ◆ 1 VW784 4-Port 4K HDMI Input Board for VW Series / VW884 4-Port 4K HDMI Output Board for VW Series
- ◆ 1 user instructions

VW754

- ◆ 1 VVW754 4-Channel 4K H.265 IP Stream Decoder Input Card
- ◆ 1 user instructions

Contents

| | |
|-----------------------------|------|
| Compliance Statements | ii |
| User Information | iv |
| Online Registration | iv |
| Telephone Support | iv |
| User Notice..... | iv |
| Product Information | v |
| Package Contents..... | v |
| VW1608..... | v |
| VW3620..... | v |
| VW784 / VW884 | v |
| VW754 | vi |
| About this Manual | xiii |
| Conventions..... | xiv |

1. Introduction

| | |
|--|----|
| Overview | 1 |
| VW1608..... | 1 |
| VW3620 | 3 |
| VW784 / VW884 | 4 |
| VW754 (4-Channel 4K H.265 IP Stream Decoder Input Card) | 4 |
| Features | 5 |
| VW1608 | 5 |
| VW3620 | 7 |
| VW784 / VW884 | 8 |
| VW754 | 9 |
| Compatible Browsers | 9 |
| Optional Equipment..... | 9 |
| Components | 10 |
| VW1608 Front View | 10 |
| VW1608 Side View..... | 11 |
| VW1608 Rear View | 12 |
| VW3620 Front View | 14 |
| VW3620 Side View..... | 15 |
| VW3620 Rear View | 16 |
| VW784 Front View | 18 |
| VW884 Front View | 19 |

2. Hardware Setup

| | |
|---|----|
| Transporting and Storing the Unit | 21 |
| Installing the Power Module | 22 |
| Adjusting the Cable Strap | 26 |
| Installation | 27 |
| VW1608 | 27 |
| VW3620 | 30 |
| Input / Output Board Installation and Removal | 33 |
| Installing the Input / Output Boards | 33 |
| Removing the I/O Board | 35 |
| Rack Mounting | 36 |
| Mounting with Brackets | 37 |

3. Front Panel Operation

| | |
|--|----|
| Overview | 41 |
| Front Panel Pushbuttons | 42 |
| Front Panel LCD | 44 |
| Standby Mode | 44 |
| Idle Screen | 44 |
| LCD Password | 45 |
| Menu | 47 |
| System Info | 48 |
| Local Output Settings | 48 |
| Security | 49 |
| Mode | 49 |
| Timeout | 50 |
| Change Password | 50 |
| Settings | 51 |
| Baud Rate | 51 |
| EDID Mode | 52 |
| OSD | 52 |
| Network | 53 |
| F/W upgrade | 55 |
| Local Output | 57 |
| Zone View | 58 |
| Zone View (Video Wall Mode) | 58 |
| Zone View – Cascade (Video Wall Mode) | 59 |
| Zone View (Independent Mode) | 60 |
| Zone View – Cascade (Independent Mode) | 61 |

| | |
|--------------------------|----|
| Single Source View | 63 |
| Array Source View | 64 |
| Profile | 65 |

4. Browser Operation

| | |
|--|-----|
| Overview | 67 |
| Logging In..... | 67 |
| Display Configuration | 69 |
| Design Mode – Landing Page After Login | 75 |
| Menu Bar | 76 |
| Setting the Standby Mode | 76 |
| Source Array..... | 77 |
| Scheduling | 78 |
| Create a Scheduled Task..... | 79 |
| Scheduled Tasks Management..... | 81 |
| Design Mode | 82 |
| Understanding Display Zones | 82 |
| Understanding Profiles and Profile List | 82 |
| Interactive Functions on Design Mode Tab | 82 |
| Multiview Window Management..... | 91 |
| Create a Multiview Window..... | 91 |
| Configure a Multiview Window | 93 |
| Customized Video Source | 94 |
| Profile Management | 95 |
| Creating a Profile | 95 |
| Edit a Profile..... | 96 |
| Apply a Profile | 97 |
| Preview | 98 |
| Delete a Profile | 99 |
| System Settings | 100 |
| Overview | 101 |
| General..... | 102 |
| Port Settings..... | 103 |
| HDCP | 104 |
| Source Settings | 104 |
| Zone Settings | 105 |
| Scaler Resolution | 105 |
| Port Name..... | 107 |
| EDID | 108 |

| | |
|--------------------------------------|-----|
| EDID Mode | 109 |
| EDID & CEA Description | 110 |
| CEC | 111 |
| HDR | 112 |
| Status | 113 |
| 4K60 Mode Configuration | 114 |
| Enable 4K60 Mode | 114 |
| Maintenance | 117 |
| System Setup | 118 |
| User Account | 119 |
| Add a New User | 119 |
| Edit / Delete an Existing User | 121 |
| Network | 122 |
| Security | 124 |

5. Tablet Control

| | |
|---|-----|
| Overview | 127 |
| Logging In | 128 |
| Profile List Operation | 132 |
| Opening a Profile | 132 |
| Editing a Profile | 133 |
| Single Source Operation | 135 |
| Adding a Window | 135 |
| Video Source Management | 136 |
| Multiview Window Configuration | 138 |
| Create a Multiview Window | 138 |
| Editing / Deleting a Multiview Window | 140 |
| Window Behavior and Adjustment | 142 |
| Adding an Image | 142 |
| Layout Management | 143 |
| Resizing | 143 |
| Cropping | 144 |

6. Device Chaining

| | |
|-----------------------|-----|
| Overview | 147 |
| Hardware Setup | 148 |
| Connection Rule | 148 |
| Backup Mode | 148 |

| | |
|--|-----|
| Expansion Mode..... | 149 |
| Example System Architecture | 150 |
| Browser Operation..... | 151 |
| Chain Status..... | 151 |
| Chain Mode | 152 |
| Device Chain Configuration..... | 153 |
| Enabling Chain Mode..... | 153 |
| Disabling Chain Mode | 155 |
| Chain Mode Behavior and UI Restrictions..... | 157 |
| Backup Mode | 158 |
| Behavior and UI Restrictions | 159 |
| Recovery & Sync Notifications..... | 159 |
| Expansion Mode..... | 161 |
| Behavior and UI Restrictions | 162 |
| Recovery & Sync Notifications..... | 162 |

7. VW754 IP Streaming Card

| | |
|--|-----|
| Overview | 165 |
| System Limitations | 165 |
| Hardware Overview..... | 166 |
| VW754 Front View | 166 |
| Installation Capacity | 166 |
| Installing the VW754 IP Streaming Card | 167 |
| Removing the VW754 IP Streaming Card | 167 |
| Design Mode – IP Card Tab Overview..... | 168 |
| Option Menu | 169 |
| Channel Configuration | 170 |
| Design Mode – Multiview Integration..... | 171 |
| 2 × 2 Multiview | 171 |
| 4 × 4 Multiview | 172 |
| Limitations..... | 172 |
| VW754 IP Channels in Source Array..... | 173 |
| IP Signal Management | 174 |
| Adding a New IP Signal | 175 |
| RTSP | 176 |
| Onvif..... | 177 |
| ATEN Streaming Device | 179 |
| Editing an Existed IP Signal..... | 182 |
| Connection Status | 183 |

| | |
|-------------------------------------|-----|
| Power Consumption and Warnings..... | 185 |
| IP Card Network Settings..... | 186 |

8. CLI Commands

| | |
|--|-----|
| Overview..... | 189 |
| Connecting to the Video Wall Processor via Telnet..... | 189 |
| Connecting to the Video Wall Processor via RS-232..... | 190 |
| Command Guidelines..... | 191 |
| Verification..... | 192 |
| Commands..... | 193 |
| Switch Port Command..... | 193 |
| Load Profile Commands..... | 195 |
| Move Window Command..... | 196 |
| Create New Window Command..... | 197 |
| EDID Mode Command..... | 198 |
| CEC Command..... | 199 |
| Read Command..... | 200 |
| Reset Command..... | 200 |
| Reboot Command..... | 200 |
| Baud Rate Command..... | 201 |
| Echo Command..... | 201 |
| Fan Speed Command..... | 202 |
| Alert Command..... | 203 |
| Standby Mode Command..... | 204 |

Appendix

| | |
|---------------------------|-----|
| Safety Instructions..... | 205 |
| General..... | 205 |
| Rack Mounting..... | 207 |
| Technical Support..... | 208 |
| International..... | 208 |
| Specifications..... | 209 |
| VW1608..... | 209 |
| VW3620..... | 211 |
| VW784 / VW884..... | 213 |
| VW754..... | 214 |
| ATEN Warranty Policy..... | 215 |

About this Manual

This manual covers all aspects of installation, configuration and operation of the Modular Video Wall Processor. An overview of the information found in the manual is provided below.

Chapter 1 Introduction introduces you to the Modular Video Wall Processor and its components. Its purpose, features and benefits are presented, and its front and back panel components are described.

Chapter 2 Hardware Setup describes how to set up the hardware for your Modular Matrix Solution installation.

Chapter 3 Front Panel Operation explains the fundamental concepts involved in operating the Modular Video Wall Processor at the local site via the front panel LCD display using pushbuttons.

Chapter 4 Browser Operation provides a complete description of the Modular Matrix Solution's web Graphical User Interface (GUI), and how to use it to remotely configure and operate the Modular Matrix Solution.

Chapter 5 Tablet Control describes how to control and configure the Modular Video Wall Processor using the tablet browser interface, where the user flow and UI responses may differ slightly from the PC browser version.

Chapter 6 Device Chaining explains how to set up and manage device chaining on the Modular Video Wall Processor. The procedures and interface elements described here apply to both Backup and Expansion modes. Depending on the chain configuration, the behavior of the system and the level of control available to each unit (Primary or Secondary) may vary.

Chapter 7 VW754 IP Streaming Card introduces the VW754 IP Streaming Card, including its supported protocols, configuration settings, and integration features within the Modular Video Wall Processor system.

Chapter 8 CLI Commands provides a complete list of the serial control protocol commands used via RS-232 or Telnet.

Appendix provides specifications and other technical information regarding the Modular Video Wall Processor.

Note:

- ◆ Read this manual thoroughly and follow the installation and operation procedures carefully to prevent any damage to the device or to any other connected devices.
 - ◆ The VW3620 product firmware may have been updated with new features after the release of this manual. For an up-to-date VW3620 user manual, visit <http://www.aten.com/global/en/>
-

Conventions

This manual uses the following conventions:

- | | |
|---|--|
| <code>Monospaced</code> | Indicates text that you should key in. |
| [] | Indicates keys you should press. For example, [Enter] means to press the Enter key. If keys need to be chorded, they appear together in the same bracket with a plus sign between them: [Ctrl+Alt]. |
| 1. | Numbered lists represent procedures with sequential steps. |
| ◆ | Bullet lists provide information, but do not involve sequential steps. |
| > | Indicates selecting the option (on a menu or dialog box, for example), that comes next. For example, Start > Run means to open the <i>Start</i> menu, and then select <i>Run</i> . |
|  | Indicates critical information. |

Chapter 1

Introduction

Overview

VW1608

A 4U modular video wall processor with support for up to 16 input sources and 8 displays while featuring True 4K performance, flexible windowing technology, and enterprise-grade reliability, empowering LED video walls in space-constrained control rooms, corporate war rooms, energy centers, or any small-to-medium sized mission-critical environment.

Modular Design with Customizable I/O configurations

Purpose-built for 24/7 mission-critical operations, the modularly designed VW1608 contains 4 input board slots, 2 output board slots, and 1 CPU board slot to support up to 16 input sources and 8 displays. The ample amount of I/O board slots enable the customization of I/O combination to tailor it to any specific application. Its expansion capability also allows for decoding of multiple H.265 / H.264 streams at True 4K simultaneously via VW754 4-Channel 4K H.265 IP Stream Decoder Input Card for surveillance scenarios, improving situational awareness and decision-making.

Precision-Driven Visual Performance

Thanks to VW1608's FPGA architecture, it supports resolutions up to True 4K, near-zero-second seamless source switching, and outputs without delay. The built-in scaler allows for mix-and-match of displays of different resolutions and upscaling of video signals for crystal clear, accurate imagery regardless of the display size or type from LED, LCD, DLP, to other large screens. Besides, FrameSync technology ensures that all output signals remain synchronized to prevent image tearing and frame mismatch, providing seamless playback across multiple displays.

Optimum Component Redundancy, Optimized Serviceability

To keep operations running when every second counts, the VW1608 boasts optimum component redundancy via a hot-standby CPU control board, dual redundant power boards, hot-swappable I/O boards as well as a fan module, reducing downtime for 24/7 operation in critical spaces.

Daisy-Chainable for Backup and Expansion Purposes

An extra level of reliability is added with it being cascadable for backup / expansion purposes. The Backup Mode enables real-time replication of the system settings and configurations across two VW1608s. Whenever the primary unit malfunctions, the backup unit automatically takes control of video wall outputs to ensure uninterrupted display. As for the Expansion Mode, up to three VW1608s can be daisy-chained together to run as a unified system to drive a larger video wall of up to 24 displays while allowing for centralized control by the primary unit, synchronized video output clocking across all units, and consistent, frame-accurate playback without tearing or drift.

Advanced Windowing Technology

Window management from cropping, overlapping, cross-screen, picture-by-picture, picture-in-picture, to bezel compensation, and more is made easy with the powerful video wall engine. Plus, the VW1608 is able to output in real-time in any size based on the correct aspect ratio. Customizable logos / color schemes / calendar / clock / scrolling texts can be added for a tailored view for every piece of crucial information, meeting the specific needs in every mission-critical settings effectively.

Configure and Control via Multiple Methods Locally or From Afar

The VW1608 supports multiple control and monitor methods, including local HDMI output, RS-232, Ethernet, front panel buttons, web GUI, Telnet, and SSH, to overcome geographical limitations.

VW3620

Purpose-built to meet the increasingly stringent system performance requirements in mission-critical applications, the VW3620 is a 7U, modular True 4K video wall processor with 7 input slots, 5 output slots, and 2 function board slots, which also work as input board slots, to support up to 36 input sources and 20 display terminals while being able to handle True 4K sources* without delay. Advanced 4K@60 4:4:4 scaling technology plus the signal processing capability allow the VW3620 to deliver astonishing, accurate True 4K imagery. The hot-swappable, redundant CPU control board and dual power modules add an extra level of reliability. With input / output cards and cooling fan module also coming hot-swappable, the VW3620 guarantees 24/7 operation and easy maintenance in scenarios where system malfunction or shutdown is unacceptable.

Note: By enabling the 4K@60 mode, you are able to play the video at 4K resolution (3840 × 2160) and 60 fps (frames per second) from port A and port C of the selected input card (VW784), which supports up to four 4K@30Hz inputs or two 4K@60Hz inputs.

Thanks to ATEN's cutting-edge windowing technology, the VW3620 supports multiple video walls with varying resolutions. Nearly restriction-free window placement functionality allows source cropping, overlap, and more, displaying a tailored view of every piece of crucial information. Organization logos, color schemes, calendar, clock, and scrolling text can be added to the video walls to widely broaden applications. Moreover, the VW3620 can be configured and controlled via various methods to overcome geographical limitations, from RS-232, Ethernet, the front panel buttons, web GUI to RESTful API. Integration with ATEN Control System and the 3rd party devices is allowed through its RS-232 and Ethernet interfaces as well as the support for RESTful APIs.

The VW3620's unrivalled video wall processing power, configurability and reliability have made it suitable for a range of mission-critical video wall applications, including command centers, control rooms, public security organizations, governments, or other large-scale digital signage scenarios such as exhibitions, broadcasting, and education organizations.

VW784 / VW884

VW784 / VW884 is a 4-port 4K HDMI input / output board built to work with VW3620 Modular Video Wall Processor, with VW784 taking 4 HDMI sources and VW884 enabling routing of 4 HDMI signals to 4 displays, meeting the increasingly stringent video wall requirements in mission-critical applications. With the support for Seamless Switch™, the VW784 / VW884 allows real-time video switching and stable signal transmission.

The EDID Expert™ technology enables the selection of optimum EDID settings for smooth power-up, high quality display and use of the best video resolutions across different screens. A True 4K scaler is built into VW884 to handle different video resolutions. In addition, the VW784 / VW884 supports hot-swappable installation to give system integrators great flexibility and efficiency for maintenance.

VW754 (4-Channel 4K H.265 IP Stream Decoder Input Card)

Built to work with ATEN's VW3620 Modular Video Wall Processor, the VW754 seamlessly accepts H.265/H.264 streams from IP cameras/Network Video Recorders (NVRs) and decodes up to four channels at 4K @ 60 Hz simultaneously. Each decoded stream is assignable to a preferred output channel within the VW3620 configuration. The VW754 facilitates seamless integration with any mainstream IP-based video system on account of its compliance with ONVIF Profile S and the support for RTSP.

Hot swap capability helps enhance flexibility when it comes to maintenance, especially in critical settings that need constant uptime. These highlights have made the VW754 ideal for mission-critical scenarios that involve multiple IP cameras to improve situational awareness and decision-making efficiency, such as surveillance control rooms, command centers, transportation sites, and even military and government environments.

Features

VW1608

4U modular chassis with ample slot amount for system control and expansion

- ◆ Accepts up to 16 HDMI input ports and 8 HDMI output ports
- ◆ Compact, yet competent for LED video walls in small-to-medium sized mission-critical environments
- ◆ Modular board compatibility – Contains 7 board slots (4 input card slots, 2 output card slots, and 1 CPU board slot) to support multiple I/O boards for flexible configuration and future expandability

Superior Visual Quality for Mission-Critical Communications

- ◆ FPGA architecture – supports True 4K inputs, near-zero-second seamless source switching, and outputs without delay
- ◆ True 4K@60Hz (4:4:4) scalability – supports custom resolutions and enables upscaling of video signals for crystal clear, accurate imagery regardless of the display size or type from LED, LCD, DLP, to other large screens
- ◆ Decodes high density H.265 / H.264 IP channels (via VW754) – ideal for surveillance control rooms and real-time monitoring scenarios
- ◆ Advanced video wall engine – allows easy window management via cropping, overlapping, picture-by-picture, picture-in-picture, bezel compensation, and more
- ◆ Multi-resolution support – allows mix-and-match of displays of different resolutions
- ◆ FrameSync – ensures that all output signals remain synchronized to prevent image tearing and frame mismatch, providing seamless playback across multiple displays
- ◆ EDID Expert™ – selects optimum EDID settings for smooth power-up, high quality display and use of the best video resolution across different screens
- ◆ Customizable logos / color schemes / calendar / clock / scrolling texts

Reliable 24/7 Operation

- ◆ Backup Mode 2x VW1608s daisy chain – the secondary unit continuously mirrors all system settings and configurations from a primary one in real time and takes control automatically when primary unit malfunction occurs for uninterrupted display performance
- ◆ Expansion Mode with 3x VW1608s daisy chain – up to 24 display outputs supported for larger video wall installation with centralized control being conducted by the primary unit while ensuring synchronized video output clocks across all units and consistent, frame-accurate playback without tearing
- ◆ Optimum component redundancy via a hot-standby CPU control board, dual redundant power boards (2 slots), and hot-swappable I/O boards as well as fan module

Direct and Remote Configurations and Control Methods

- ◆ Direct control via RS-232 / Ethernet and the front panel buttons
- ◆ Local HDMI output – monitor input signals and video wall layouts via Single / Array mode at up to 1080p in real-time from one display
- ◆ Remote control via web GUI, Telnet, and SSH to preview input signals in real-time and control outputs including content placement and management of up to 4 canvases
- ◆ Multiview – source monitoring in 2x2 or 4x4 layouts from a single display
- ◆ Integration with ATEN Control System and the 3rd party devices via RS232 / Ethernet / RESTful API

VW3620

- ◆ Processes up to 36 input sources and manages up to 20 displays in any sizes at varying resolutions from a single 7U chassis
- ◆ Modular construction with 7 input slots, 5 output slots, and 2 function board slots, which also work as input board slots, to meet various expansion needs
- ◆ FPGA hardware architecture—handles True 4K input sources, supports near-zero-second seamless source switching, and transmits high quality video streams without delay
- ◆ True 4K@60 scalability with 4:4:4 signal processing—supports custom resolutions and enables upscaling of video signals for crystal clear, accurate imagery regardless of the display size or type from LED, LCD, DLP, to other large screens
- ◆ Reliable 24/7 operation with hot-swappable, redundant CPU control board and dual power modules, and hot-swappable input / output cards and cooling fan module
- ◆ HDMI (Deep Color, True 4K); HDCP 2.2 compliant
- ◆ Powerful windowing technology for nearly restriction-free content placement—outputs signals in real-time in customizable layouts, such as PiP, PbP, source cropping, overlapping, and spreading across multiple screens, and in any sizes based on the correct aspect ratio
- ◆ Seamless Switch™—unifies video formats to provide continuous video streams, real-time switching and stable signal transmissions
- ◆ Powerful windowing technology for nearly restriction-free content placement—outputs signals in real-time in customizable layouts, such as PiP, PbP, source cropping, overlapping, and spreading across multiple screens, and in any sizes based on the correct aspect ratio
- ◆ Supports Multiview—content source monitoring in 2 × 2 or 4 × 4 layouts from a single display
- ◆ Customizable elements to enhance organization identity and video wall presentation including logos, color schemes, calendar, clock, and scrolling text
- ◆ Direct control via RS-232 / Ethernet connection and the front panel buttons
- ◆ Remote control via intuitive Web GUI to preview input signals in real-time and control outputs including content placement and management of up to 4 canvases

- ◆ Local HDMI output—monitoring of video input signals and video wall layouts via Single / Array mode at up to 1080p in real-time from one display
- ◆ Integration with ATEN Control System and the 3rd party devices via RS-232 / Ethernet / RESTful API
- ◆ Supports FrameSync—avoids image tearing by synchronizing the scaler output frame rate to the input signal frame rate
- ◆ EDID Expert™—selects optimum EDID settings for smooth power-up, high-quality display and use of the best video resolution across different screens
- ◆ Supports SSH to strengthen data and information protection
- ◆ Perfect for mission-critical video wall applications, including command centers, control rooms, public security organizations, governments, or other large-scale digital signage scenarios

VW784 / VW884

- ◆ Works with VW3620 to take 4 HDMI sources (VW784) and enable routing of 4 HDMI signals to 4 displays (VW884) for optimum flexibility
- ◆ Supports resolutions up to 4K for superior video quality
- ◆ True 4K @ 60 Hz scalability—supports custom resolutions and enables upscaling of signals for crystal clear, accurate imagery regardless of the display size or type from LED, LCD, DLP, to other large screens (VW884)
- ◆ Supports HDR, HDR+, and Dolby Vision
- ◆ Seamless Switch—unifies video formats to provide continuous video streams, real-time switching, and stable signal transmissions
- ◆ EDID Expert—selects optimum EDID settings for smooth power-up and the highest quality display
- ◆ HDMI (Deep Color, 4K); HDCP 2.2 Compatible
- ◆ Supports hot-swappable installation for great system integration flexibility and maintenance efficiency
- ◆ Output rates matched to input rates to prevent lagging and freezing, ensuring stable, smooth video display
- ◆ Consumer Electronics Control (CEC)

VW754

- ◆ Seamlessly decodes 4x H.265/H.264 IP camera streams at UHD 4K@60Hz simultaneously or up to 64x SD or 36x 720p streams
- ◆ Decoded stream can be independently assigned to any preferred output window on the Video Wall Processor
- ◆ ONVIF Profile S compliant for seamless integration with mainstream IP cameras and NVRs
- ◆ Supports RTSP protocol
- ◆ Modular design that works with ATEN Modular Video Wall Processors
- ◆ Hot-swappable
- ◆ Ideal for mission-critical multi-IP camera / multi-source IP deployments such as surveillance control rooms, command centers, transportation sites in military and government environments

Compatible Browsers

In order to achieve the best performance, the browsers listed in the table below are recommended to be used with the VW3620 Web GUI.

| OS | Java Version | Browser |
|--------------------------------|---------------------|---------|
| Windows 10 (64 bit) | V1.8.0_391 (64 bit) | Chrome |
| | | Edge |
| | | Firefox |
| | | Opera |
| Windows 10 Enterprise (64 bit) | | IE |
| MAC 14.1 | Safari | |

Optional Equipment

Purchase optional equipment such as a secondary power module, fan, or rack mount kit to get the most out of your ATEN Video Wall Processor. For more information, go to <https://www.aten.com/global/en/>

Components

VW1608 Front View

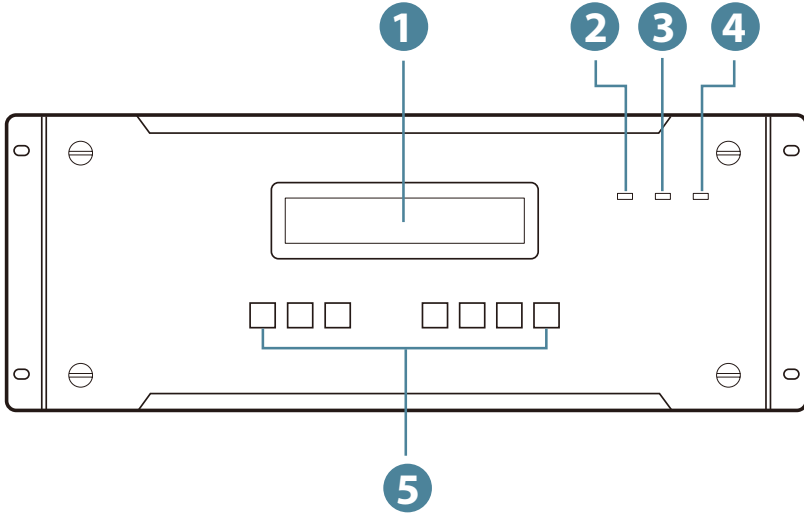

| No. | Component | Description |
|-----|---------------------|---|
| 1 | LCD display | The LCD display shows the options for configuring and operating the Video Wall Processor. See <i>Front Panel Pushbuttons</i> , page 42, for details. |
| 2 | alarm LED | The LED lights red to indicate that a system error occurred. To obtain details for the issue, log in to the Web GUI. The alarm LED goes off once the system error is fixed. |
| 3 | redundant power LED | The LED lights green to indicate that the redundant power module is in operation. |
| 4 | primary power LED | The primary power LED gives the following status: <ul style="list-style-type: none"> ◆ lights green Indicates that the primary power module is in operation. ◆ blinks Indicates that the unit is in sleep mode. |

| No. | Component | Description |
|-----|----------------------|--|
| 5 | function pushbuttons | Use the pushbuttons to control and configure the options available to the unit. See <i>Front Panel Pushbuttons</i> , page 42, for details. Note: The pushbuttons have LEDs that light to indicate they have been selected. |

VW1608 Side View

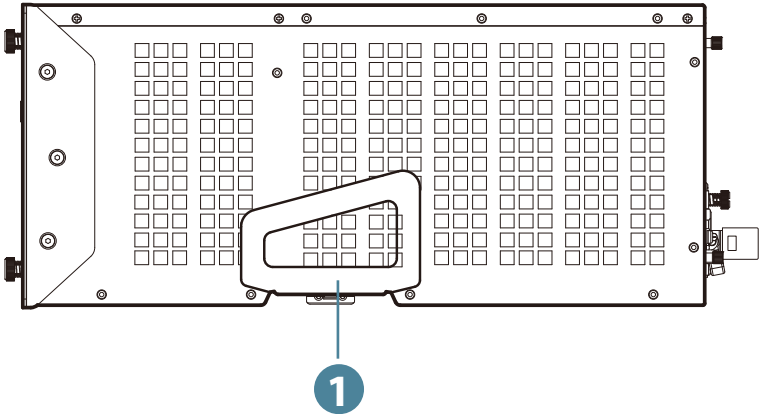

| No. | Component | Description |
|-----|------------------|--|
| 1 | recessed handles | The two side handles are used to transport the unit. Push in to lock and unlock the handles so that they can be used to carry the unit and be tucked away when not in use. |

VW1608 Rear View

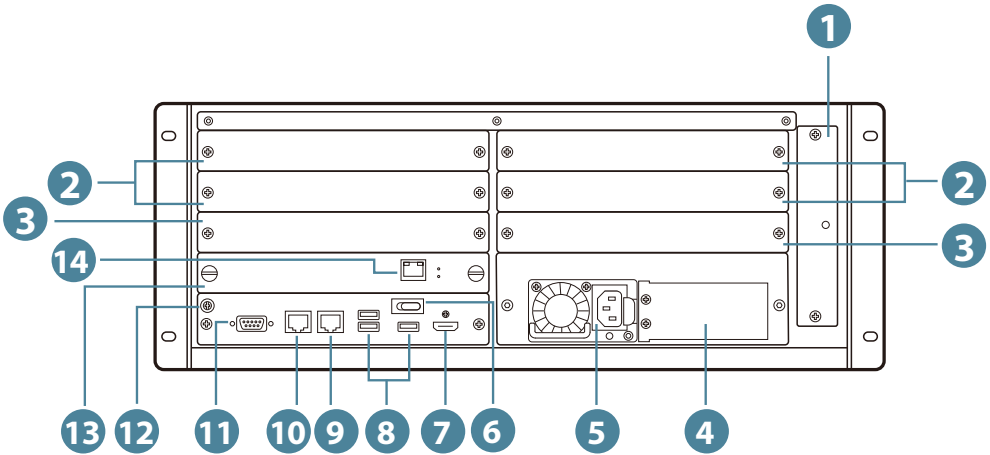

| No. | Component | Description |
|-----|--------------------------|---|
| 1 | fan module | The fan module is used for cooling down the unit that generates heat in operation. |
| 2 | video input board slots | Optionally install the VW784 video input board(s) to the video input board slot(s) for expansion. Note: The top row of input board slots are reserved for potential function board expansion. |
| 3 | video output board slots | Optionally install the VW884 video output board(s) to the video output board slot(s) for expansion. |
| 4 | redundant power slot | Optionally install an additional power supply for redundant power protection. For more information about the power module, visit the product web page. |
| 5 | primary power module | Connect the supplied power cord to the unit's primary power socket. See <i>Installing the Power Module</i> , page 22 for how to install the power module to the video wall processor. |

| No. | Component | Description |
|-----|---------------------------|--|
| 6 | power switch | Use the power switch to power the unit on and off. |
| 7 | system HDMI local output | Connect to an HDMI-enabled display for monitoring, previewing, and controlling the real-time content. |
| 8 | USB Type-A ports | Connect your data storage device(s) to the USB Type-A port(s). Currently the USB ports support storage and firmware upgrade. |
| 9 | RJ-45 port (chain out) | Connect to the RJ-45 port (chain in) of the next VW1608 to daisy-chain the units. Note: See <i>Device Chaining</i> , page 147 for details. |
| 10 | RJ-45 port (chain in) | Connect to the RJ-45 port (chain out) of the last VW1608 to daisy-chain the units. Note: See <i>Device Chaining</i> , page 147 for details. |
| 11 | RS-232 serial port | Connect a PC or an ATEN Control Box to the RS-232 serial port for controlling the unit. |
| 12 | grounding terminal | Attach the grounding wire here. |
| 13 | CPU board | Connect the Ethernet port of the primary CPU board to the network using an Ethernet cable. |
| 14 | Ethernet port | In order to access the VW1608's web Graphical User Interface (GUI), the VW1608 must be connected to the network. The cable that connects the VW1608 to your LAN plugs in here. For further details, see <i>Installation</i> page 27. |

VW3620 Front View

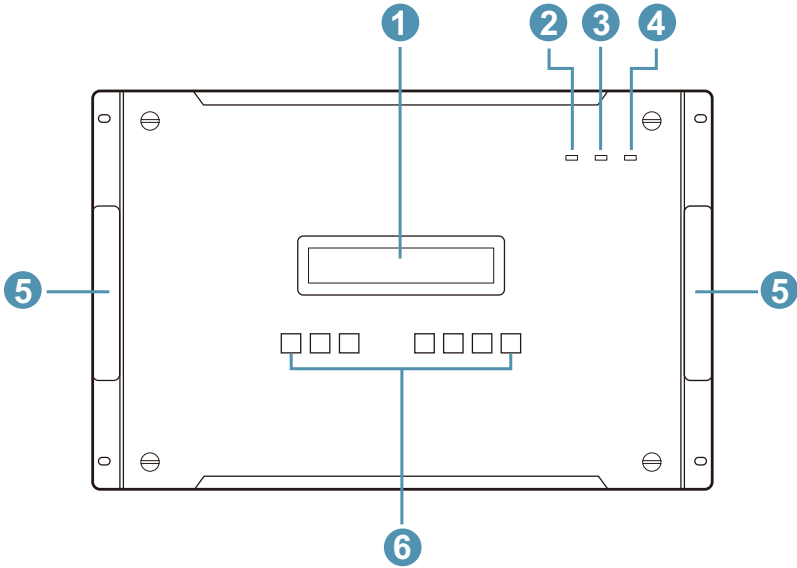

| No. | Component | Description |
|-----|---------------------|---|
| 1 | LCD display | The LCD display shows the options for configuring and operating the VW3620. See <i>Front Panel Pushbuttons</i> , page 42, for details. |
| 2 | alarm LED | The LED lights red to indicate that a system error occurred. To obtain details for the issue, log in to the Web GUI. The alarm LED goes off once the system error is fixed. |
| 3 | redundant power LED | The LED lights green to indicate that the redundant power module is in operation. |
| 4 | primary power LED | The primary power LED gives the following status: <ul style="list-style-type: none"> ◆ lights green Indicates that the primary power module is in operation. ◆ blinks Indicates that the unit is in sleep mode. |
| 5 | handles | The two front handles are used to install the unit into a rack. |

| No. | Component | Description |
|-----|----------------------|--|
| 6 | function pushbuttons | Use the pushbuttons to control and configure the options available to the unit. See <i>Front Panel Pushbuttons</i> , page 42, for details. Note: The pushbuttons have LEDs that light to indicate they have been selected. |

VW3620 Side View

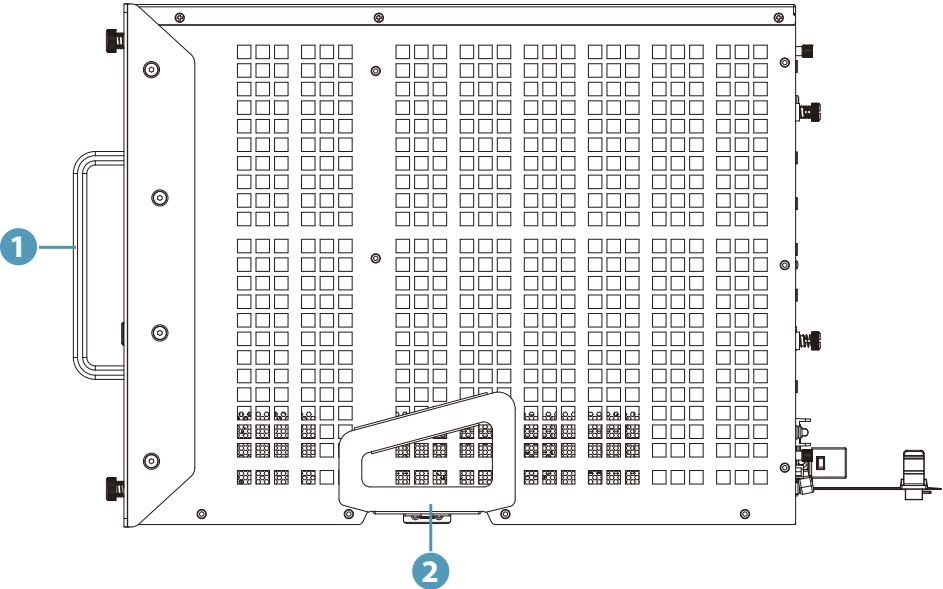

| No. | Component | Description |
|-----|------------------|--|
| 1 | handles | The two front handles are used to install the unit into a rack. |
| 2 | recessed handles | The two side handles are used to transport the unit. Push in to lock and unlock the handles so that they can be used to carry the unit and be tucked away when not in use. |

VW3620 Rear View

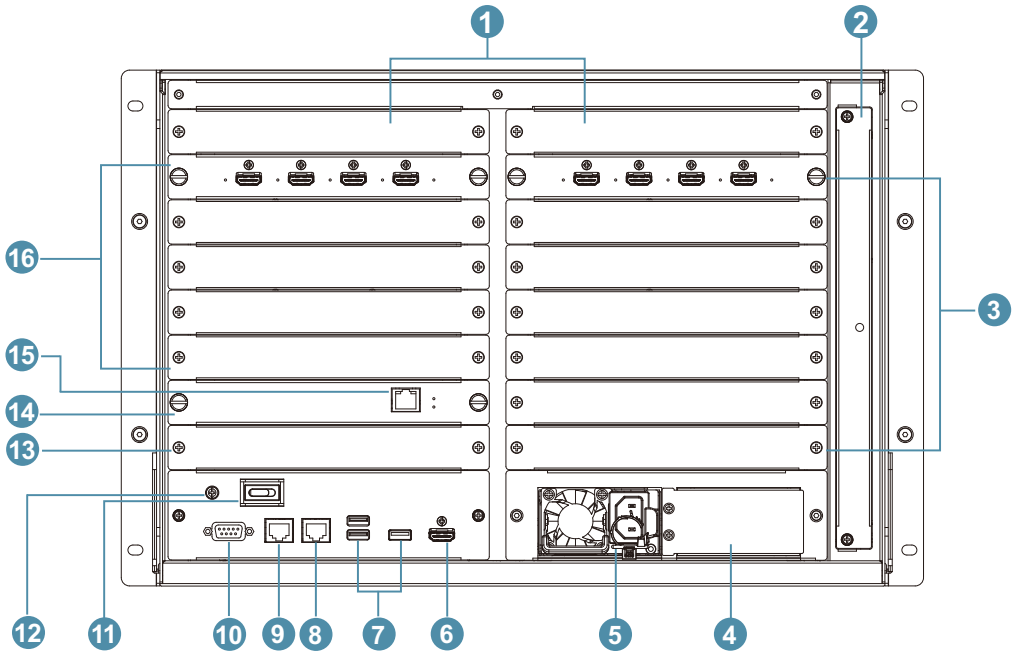

| No. | Component | Description |
|-----|--|--|
| 1 | function board / video input board slots | Optionally install the VW784 video input board(s) to the function board / video input board slot(s) for expansion. |
| 2 | fan module | The fan module is used for cooling down the unit that generates heat in operation. |
| 3 | video input board slots | Optionally install the VW784 video input board(s) to the video input board slot(s) for expansion. |
| 4 | redundant power slot | Optionally install an additional power supply for redundant power protection. For more information about the power module, visit the product web page. |

| No. | Component | Description |
|-----|--------------------------|--|
| 5 | primary power module | Connect the supplied power cord to the unit's primary power socket. See <i>Installing the Power Module</i> , page 22 for how to install the power module to the VW3620 video wall processor. |
| 6 | system HDMI local output | Connect to an HDMI-enabled display for monitoring, previewing, and controlling the real-time content. |
| 7 | USB Type-A ports | Connect your data storage device(s) to the USB Type-A port(s). Currently the USB ports support storage and firmware upgrade. |
| 8 | RJ-45 port (chain out) | Connect to the RJ-45 port (chain in) of the next VW3620 to daisy-chain the units. Note: See <i>Device Chaining</i> , page 147 for details. |
| 9 | RJ-45 port (chain in) | Connect to the RJ-45 port (chain out) of the last VW3620 to daisy-chain the units. Note: See <i>Device Chaining</i> , page 147 for details. |
| 10 | RS-232 serial port | Connect a PC or an ATEN Control Box to the RS-232 serial port for controlling the unit. |
| 11 | grounding terminal | Attach the grounding wire here. |
| 12 | power switch | Use the power switch to power the unit on and off. |
| 13 | redundant CPU slot | Optionally install the CPU board to VW3620's redundant CPU slot for hot-standby operation. |
| 14 | primary CPU board | Connect the Ethernet port of the primary CPU board to the network using an Ethernet cable. |
| 15 | Ethernet port | In order to access the VW3620's web Graphical User Interface (GUI), the VW3620 must be connected to the network. The cable that connects the VW3620 to your LAN plugs in here. For further details, see <i>Installation</i> page 27. |
| 16 | video output board slots | Optionally install the VW884 video output board(s) to the video output board slot(s) for expansion. |

VW784 Front View

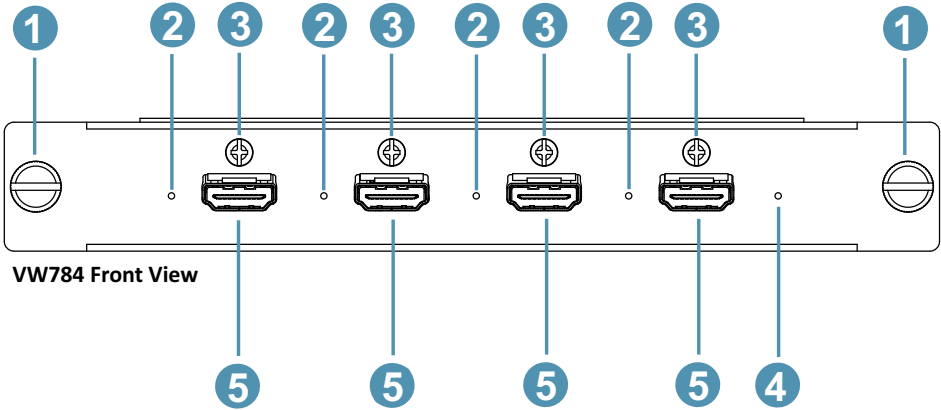

VW784 Front View

| No. | Component | Description |
|-----|----------------------|---|
| 1 | thumb screws | Tighten the screw by turning it clockwise while loosen the screw by turning it anticlockwise. |
| 2 | link LEDs | Light up to indicate stable connection with the connected source devices. |
| 3 | ATEN LockPro™ screws | Optionally secure an ATEN LockPro™ to hold the HDMI cable in place and prevent it from falling off. |
| 4 | status LED | Indicate the working status of the unit. |
| 5 | HDMI out | Connect with your video display device(s) using an HDMI cable. |

VW884 Front View

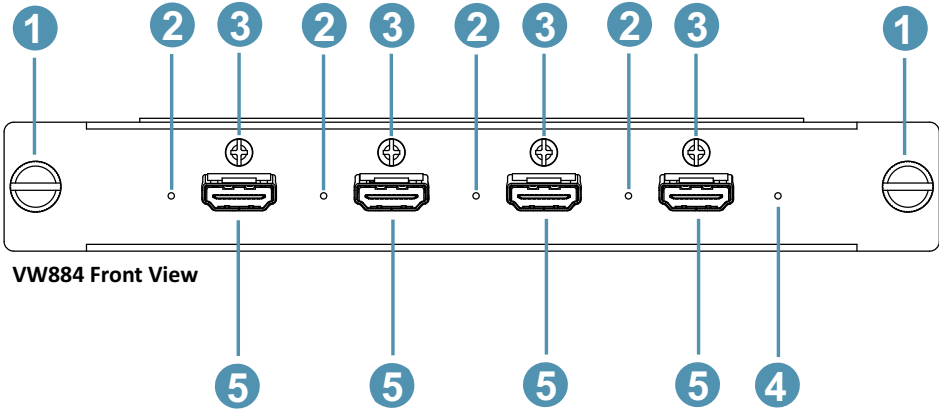

| No. | Component | Description |
|-----|----------------------|---|
| 1 | thumb screws | Tighten the screw by turning it clockwise while loosen the screw by turning it anticlockwise. |
| 2 | link LEDs | Light up to indicate stable connection with the connected source devices. |
| 3 | ATEN LockPro™ screws | Optionally secure an ATEN LockPro™ to hold the HDMI cable in place and prevent it from falling off. |
| 4 | status LED | Indicates the working status of the unit. |
| 5 | HDMI out | Connect with your video source device(s) using an HDMI cable. |

This Page Intentionally Left Blank

Chapter 2 Hardware Setup



1. Important safety information regarding the placement of this device is provided on page 205. Please review it before proceeding.
2. Make sure that the power to all devices connected to the installation are turned off. You must unplug the power cords of any computers that have the Keyboard Power On function.

Transporting and Storing the Unit

Its important to properly transport and store the Video Wall Processor. Follow the instructions below to avoid damaging the Video Wall Processor due to improper handling.

When not rack mounted, the Video Wall Processor should be placed on a flat and level surface with the bottom side down. The unit should never be placed with the front, rear or sides facing the ground.

Not for transportation



**To transport the unit, use the recessed handles,
but not the 2 front handles.**

Note: Illustrations shown using the VW3620 as an example. The above procedure applies to both the VW1608 and the VW3620.

Installing the Power Module

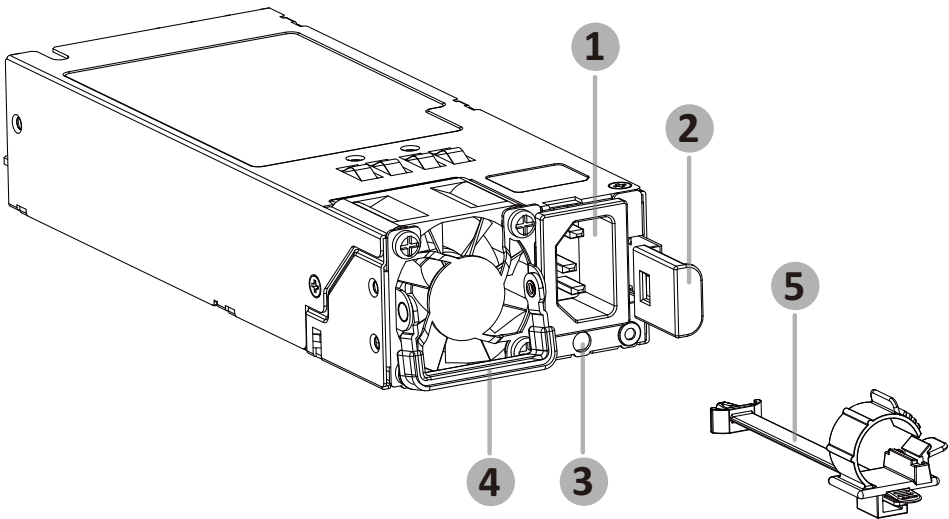

| No. | Item | Description |
|-----|----------------------------|---|
| 1 | 3-prong socket | Plugs in the supplied power cord here. |
| 2 | power module release lever | Press the lever to detach the power module from the video processor. |
| 3 | strap mounting hole | Plugs the cable strap here. |
| 4 | power module handle | Uses the handle to slide the power module in or out of the video wall processor. |
| 5 | cable strap | Attaches the cable strap onto the power module and uses it to secure the power cable that connects to the power module. |

Note: Illustrations shown using the VW3620 as an example. The same installation procedure applies to both the VW3620 and the VW1608.

To install the power module to the video wall processor, do the following:

1. Attach the cable strap to the power module by inserting it into the strap mounting hole.

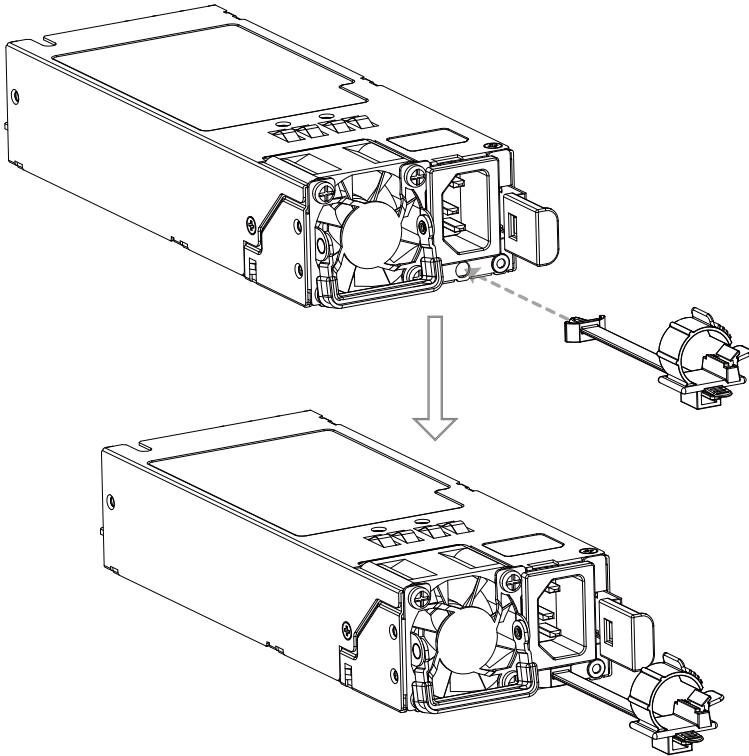

2. Install the power module to a power slot on the rear side of the video wall processor:
 - a) To install the power module to the primary power slot, follow the description as step 3 instructs.
 - b) To install the power module to the redundant power slot, remove the slot cover first.

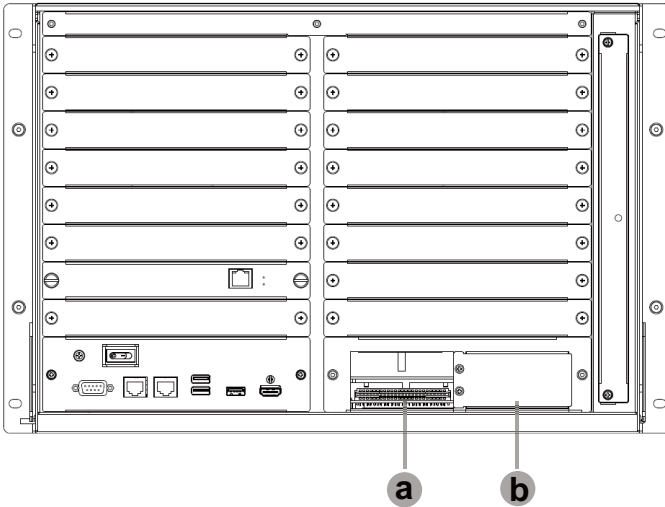

3. Slide the power module to the power slot. A click sound is made once the power module is properly installed.

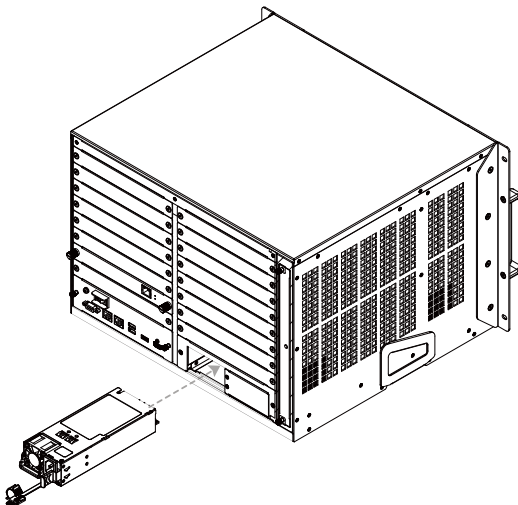

4. Plug the power cord into the 3-prong socket of the power module.

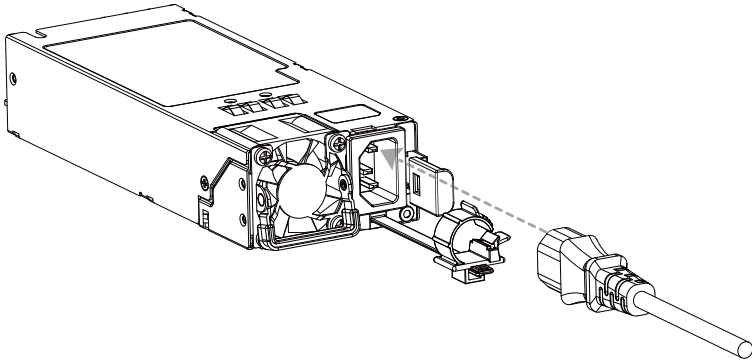

5. Secure the power cord by moving the buckle to the strain relief side of the power cord.

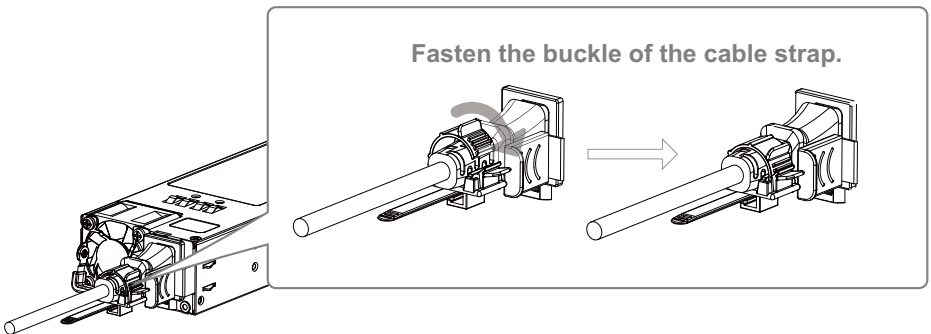
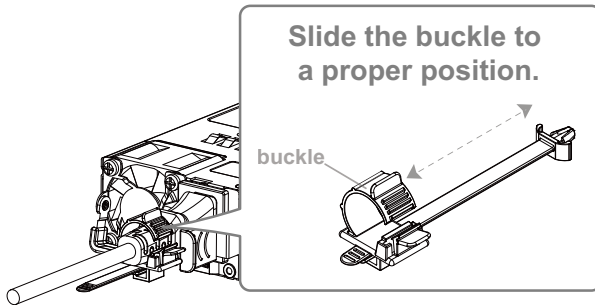

Adjusting the Cable Strap

To loosen the buckle of the cable strap, press the buckle detach lever to unlock the buckle. To adjust the position of the buckle, push down on the locking-release lever and move the buckle forward or backward to your preferred position.

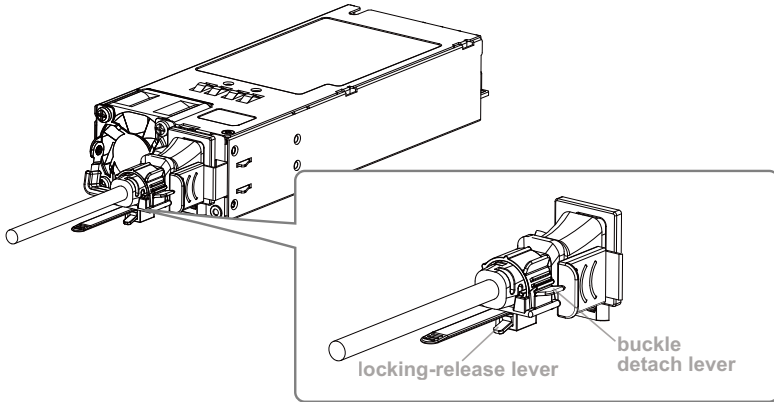

Installation

VW1608

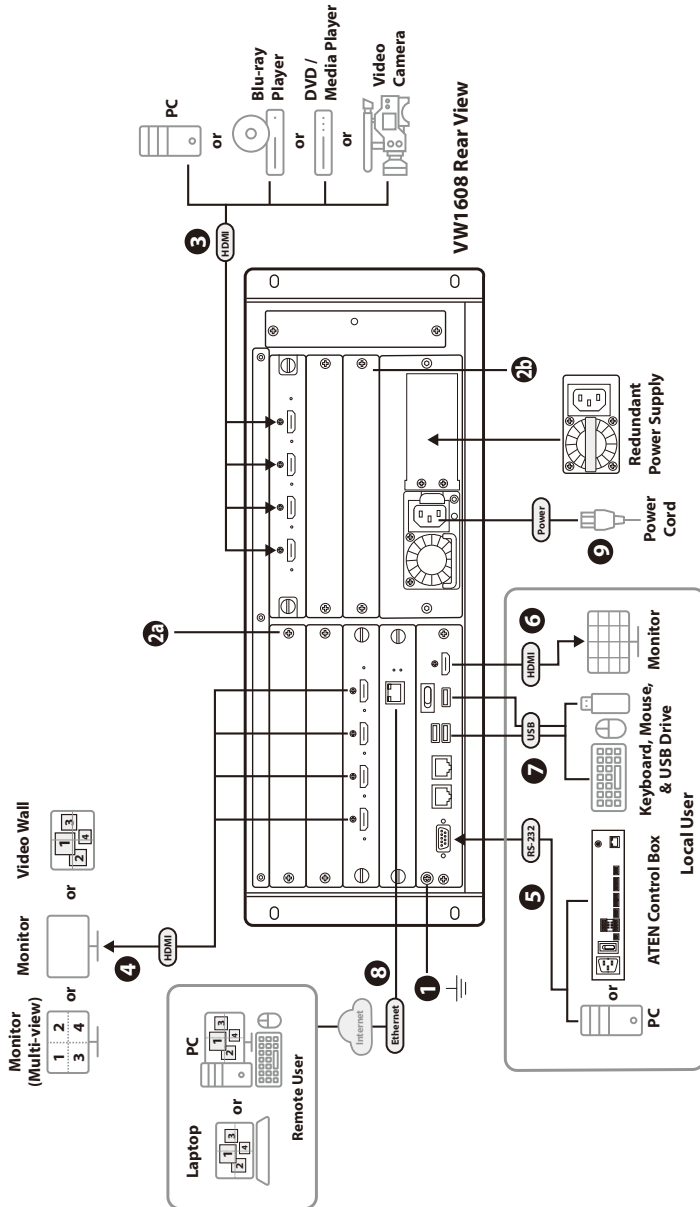

Note: 1. Install the power module onto the unit in advance. See *Installing the Power Module*, page 22, for details.

2. Make sure all the equipment you are connecting to the unit is turned off and disconnected from the power source.
-

1. Use a grounding wire to ground the unit by connecting one end of the wire to the grounding terminal, and the other end of the wire to a suitable grounded object.
-

Note: Do not omit this step. Proper grounding helps prevent damage to the unit from surges or static electricity.

2. Optionally install the video input boards/video output boards to the VW1608 for expansion.
 - a) Install the VW784 video input board(s) to the video input board slot(s).
 - b) Install the VW884 video output board(s) to the video output board slot(s).
 3. Connect your video source device(s) to the HDMI input port(s) of the VW784 video input board(s).
 4. Connect your video display device(s) to the HDMI output port(s) of the VW884 video output board(s).
 5. (Optional) To control the VW1608 via serial communication, connect your PC or ATEN Control Box to the unit's RS-232 port.
 6. (Optional) To monitor, preview, and control the real-time content, connect an HDMI-enabled display to the system HDMI local output port.
 7. (Optional) To upgrade firmware, set the video wall background image, or store the log event data, connect your data storage device(s) to the USB Type-A port(s).
-

8. (Optional) To remotely operate the VW1608 via the Web GUI, connect the Ethernet port of the primary CPU board to the network using an Ethernet cable.

9. Connect the supplied power cord to the unit's primary power socket after powering on all other connected equipment.

Note: 1. For redundant power, plug in a power module to the redundant power slot.

2. Secondary power modules are not part of the standard VW1608 package. For more information on supported power modules, go to <https://www.aten.com/global/en/>.
-

10. Turn on the unit's *power switch* (refer to page 13), and the *primary power LED* (refer to page 10) lights green to indicate the unit is powered on.

VW3620

Follow the steps below to safely install devices to the VW3620.

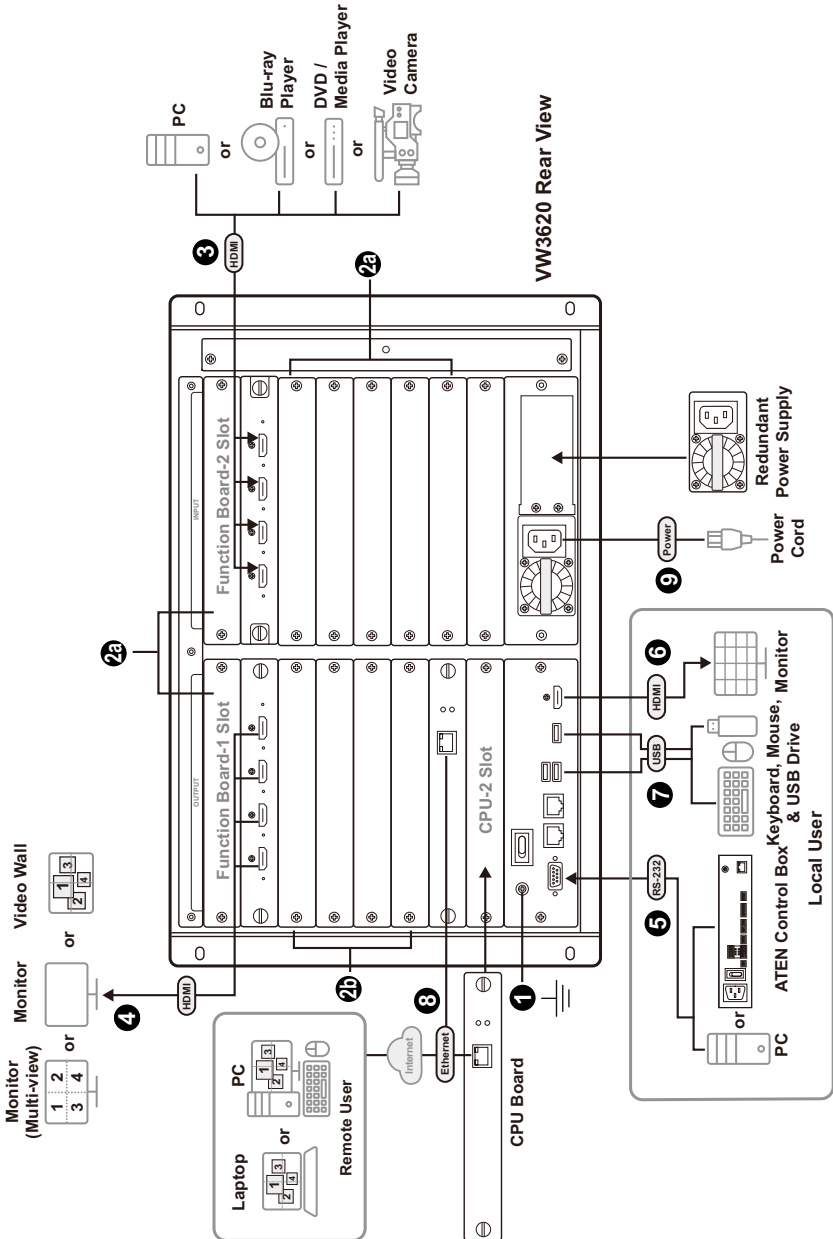

Note: 1. Install the power module onto the unit in advance. See *Installing the Power Module*, page 22, for details.

2. Make sure all the equipment you are connecting to the unit is turned off and disconnected from the power source.
-

1. Use a grounding wire to ground the unit by connecting one end of the wire to the grounding terminal, and the other end of the wire to a suitable grounded object.
-

Note: Do not omit this step. Proper grounding helps prevent damage to the unit from surges or static electricity.

2. Optionally install the video input boards/video output boards to the VW3620 for expansion.
- a) Install the VW784 video input board(s) to the **video input board slot(s)** or the **function board/video input board slot(s)**.
 - b) Install the VW884 video output board(s) to **video output board slot(s)**.
3. Connect your video source device(s) to the HDMI input port(s) of the VW784 video input board(s).
4. Connect your video display device(s) to the HDMI output port(s) of the VW884 video output board(s).
5. (Optional) To control the VW3620 via serial communication, connect your PC or ATEN Control Box to the unit's RS-232 port.
6. (Optional) To monitor, preview, and control the real-time content, connect an HDMI-enabled display to the system HDMI local output port.
7. (Optional) To upgrade firmware, set the video wall background image, or store the log event data, connect your data storage device(s) to the USB Type-A port(s).
-

8. (Optional) To remotely operate the VW3620 via the Web GUI, connect the Ethernet port of the primary CPU board to the network using an Ethernet cable.

Note: 1. Optionally install the CPU board to VW3620's redundant CPU slot for hot-standby operation.

2. Secondary CPU board is not part of the standard VW3620 package. For more information on supported CPU boards, go to <https://www.aten.com/global/en/>.

9. Connect the supplied power cord to the unit's primary power socket after powering on all other connected equipment.

Note: 1. For redundant power, plug in a power module to the redundant power slot.

2. Secondary power modules are not part of the standard VW3620 package. For more information on supported power modules, go to <https://www.aten.com/global/en/>.

10. Turn on the unit's *power switch* (refer to page 17), and the *primary power LED* (refer to page 14) lights green to indicate the unit is powered on.

Input / Output Board Installation and Removal

Installing the Input / Output Boards

To install the VW784 video input board / VW884 video output board into the video wall processor, follow the steps below.

Note: Illustrations shown using the VW3620 as an example. The same installation procedure applies to both the VW3620 and the VW1608.

1. Remove the slot covers of an output board slot and an input board slot on the rear side of the video wall processor.

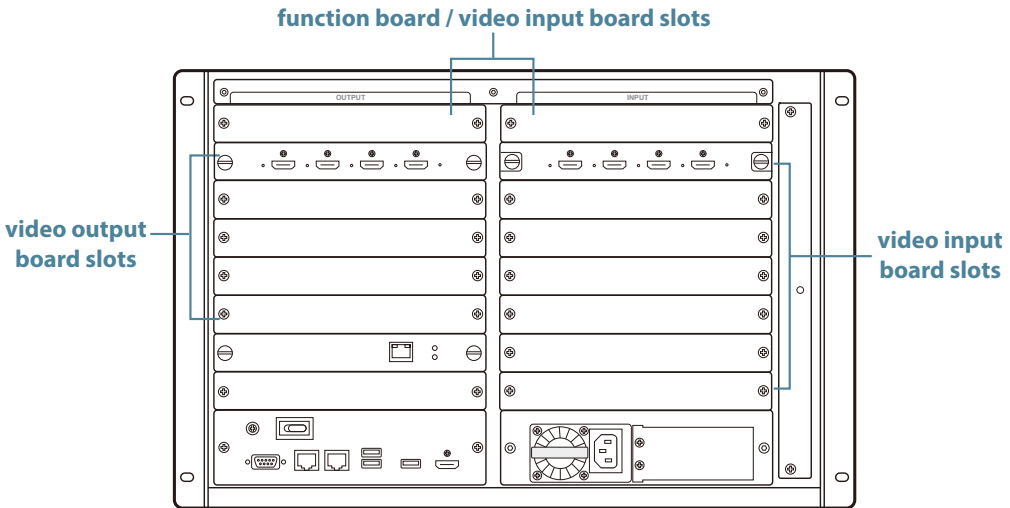

VW3620 Rear View

2. Insert the VW784 input board / VW884 output board into the slot of the Video Wall Processor.

- ◆ Install the VW784 video input board(s) to the **video input board slot(s)** or the **function board/video input board slot(s)**.

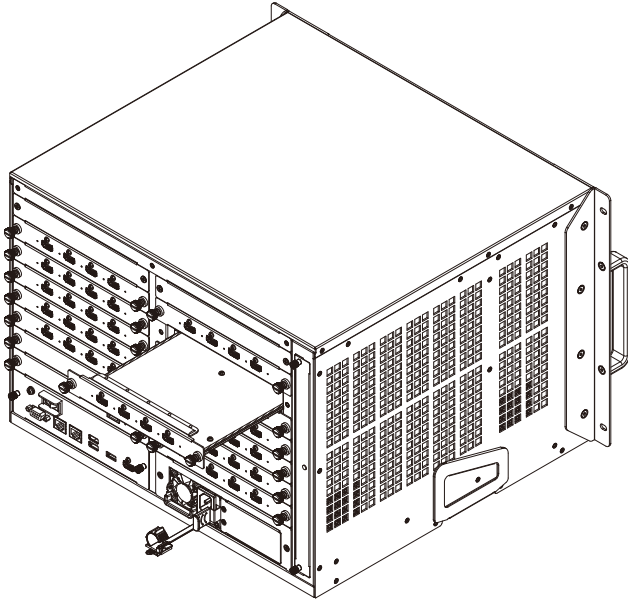

- ◆ Install the VW884 video output board(s) to **video output board slot(s)**.

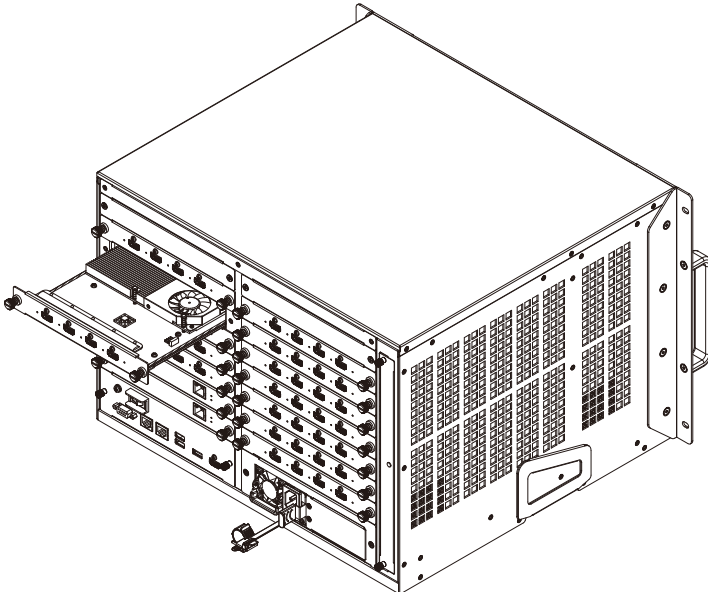

3. Gently push the VW784 video input board / VW884 video output board until it is fully seated in the slot.
4. Press down on each thumbscrew head to position it, then tighten the thumbscrew by turning it clockwise..

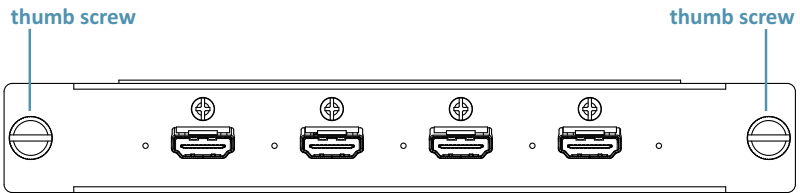

5. Repeat the above steps to install additional I/O boards.

Removing the I/O Board

To remove the VW784 video input board / VW884 video output board:

1. Alternately loosen each thumbscrew.
2. Hold the two thumb screws and then gently pull out the VW784 input board / VW884 output board.

Rack Mounting

The Video Wall Processor can be mounted in a 19" (1U) system rack. For the most convenient front panel operation at the local site, mount the unit at the front of the rack, as follows:

1. Position the unit in the front of the rack, and align the holes of the unit's built-in mounting brackets with the holes in the rack.
2. Use screws to attach the unit to the rack.

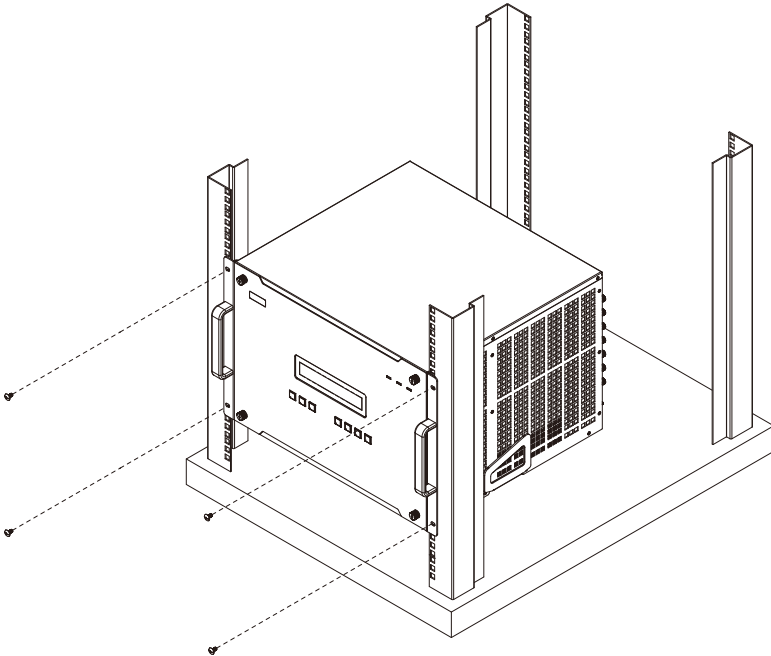

Note: 1. To ensure the Video Wall Processor has sufficient air flow, do not stack items around the unit. Proper air flow ensures safe operation and prevents the unit from overheating.

2. Illustrations shown using the VW3620 as an example. The same installation procedure applies to both the VW3620 and the VW1608.
-

Mounting with Brackets

You can also use mounting brackets to install the Video Wall Processor, as shown below.

-
- Note:** 1. The Easy Installation Mounting Kit is not included with the package. To purchase a mounting kit please contact your dealer.
2. Illustrations shown using the VW3620 as an example. The same installation procedure applies to both the VW3620 and the VW1608
-

1. Screw the mounting brackets to the rack, as shown in the diagram.

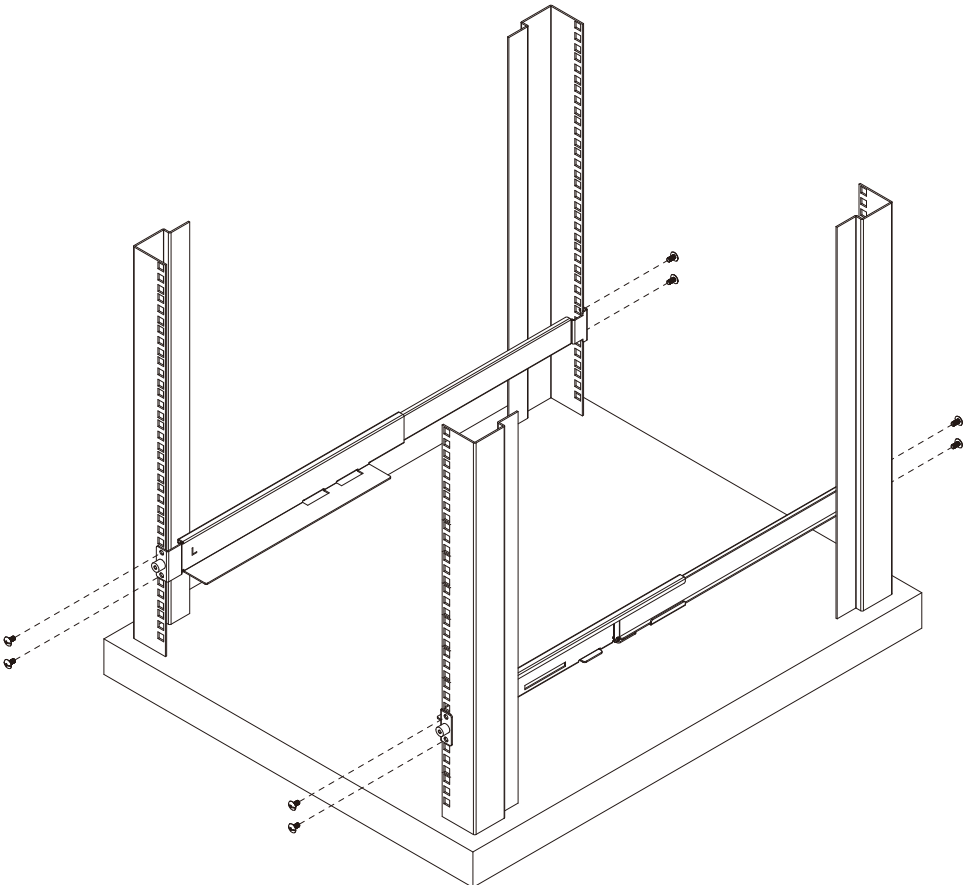

2. Push in and lock the recessed handles, and then slide the unit along the brackets.

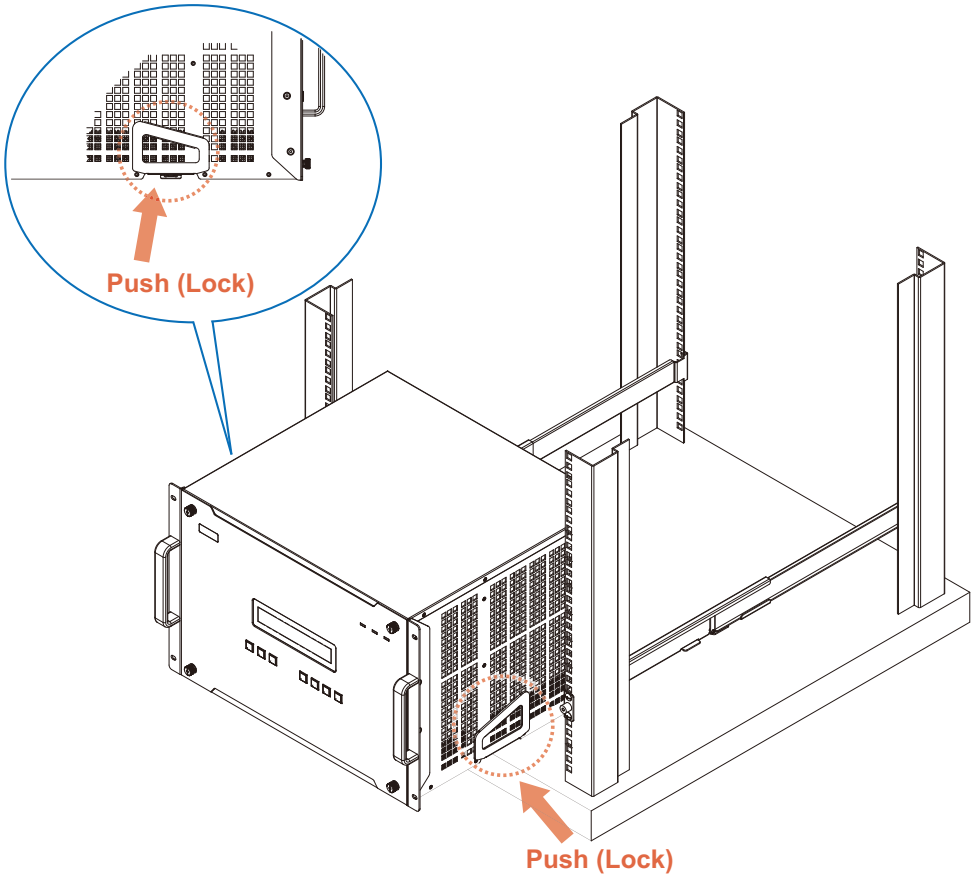

3. Screw the front panel to the rack.

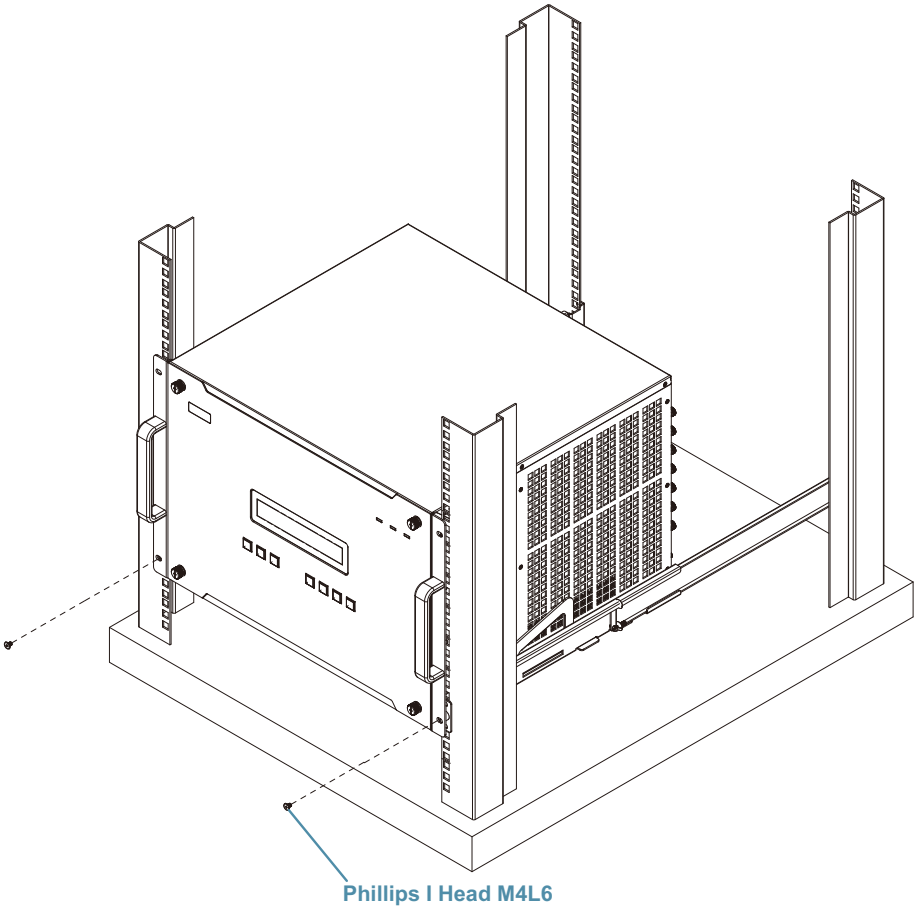

Note: To ensure the Video Wall Processor has sufficient air flow, do not stack items around the unit. Proper air flow ensures safe operation and prevents the unit from overheating.

This Page Intentionally Left Blank

Chapter 3

Front Panel Operation

Overview

The Video Wall Processor installation can be configured and operated locally via the Video Wall Processor front panel LCD and pushbuttons.

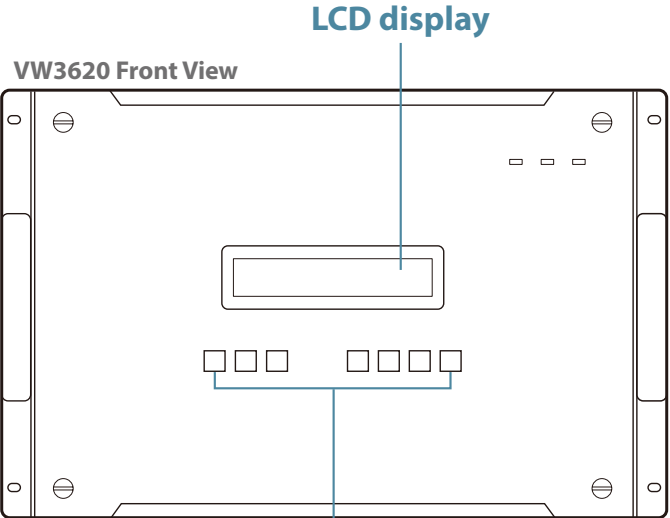
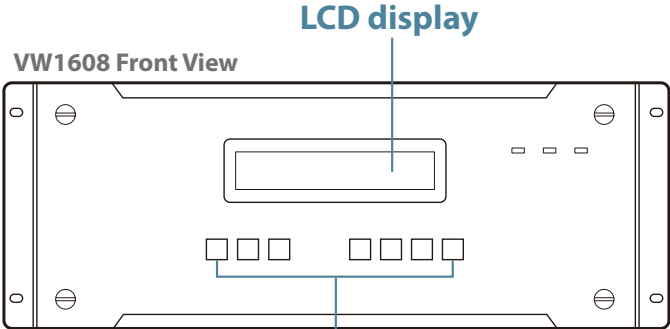

function pushbuttons

Front Panel Pushbuttons

The Video Wall Processor front panel has easy-to-use pushbuttons for selecting which video source shows on which display. The following outlines the front panel button functions:

- ◆ VW1608

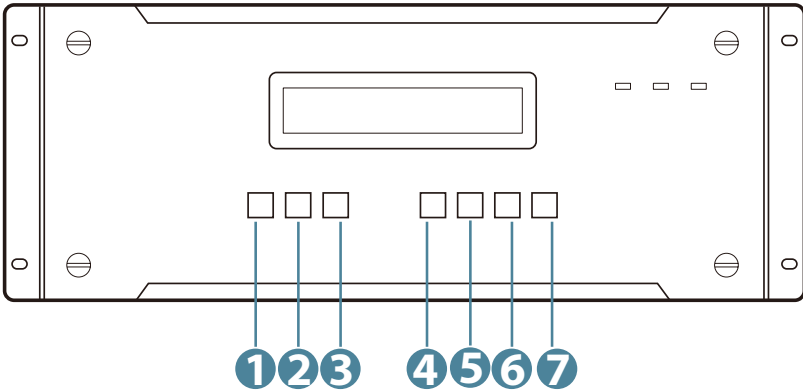

- ◆ VW3620

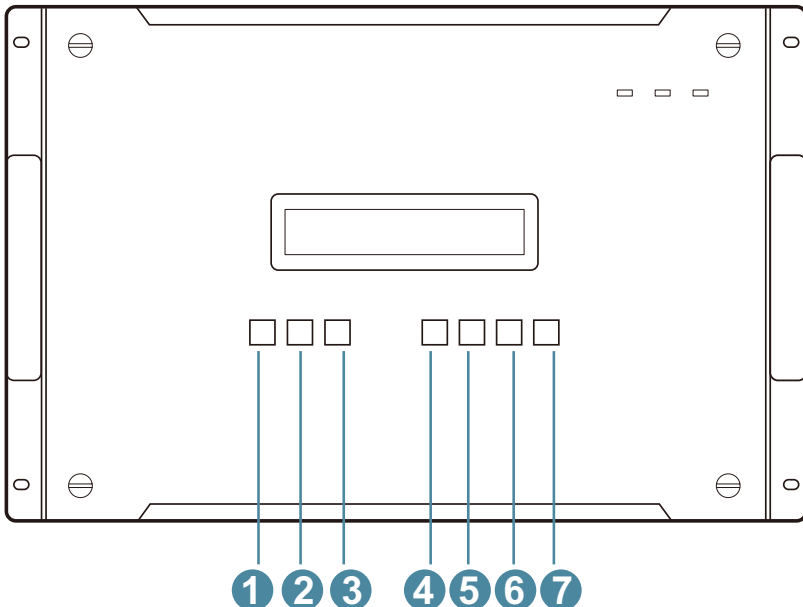

| No. | Button | Description |
|-----|--------------|---|
| 1 | Local Output | To configure and preview the content through the HDMI-enabled display connected to the unit's system HDMI local output port |
| 2 | Up | To work as the navigation button to scroll through the options listed on the on-screen display |
| 3 | Down | To work as the navigation button to scroll through the options listed on the on-screen display |
| 4 | Profile | To view, load, and apply the profile(s) that you set in the Web GUI |
| 5 | Menu | To enter the main menu screen |
| 6 | ESC | To cancel an option or go back to the previous menu screen |
| 7 | Enter | To confirm the selection |

Front Panel LCD

The Video Wall Processor features an LCD display for convenient configuration. This allows you to perform operations such as viewing the IP settings, configuring the settings of EDID/OSD/ network, selecting security settings, and loading/saving connection profiles. If the Video Wall Processor has been configured to require a password for local operation, you need enter the 4-digit password to unlock the LCD display first. See *LCD Password*, page 46 for how to unlock the password-protected LCD display.

Standby Mode

If the unit is not actively being used, it enters standby mode. To wake up the unit, follow the on-screen instruction to press the **Enter** button, and the unit will be woken up and the LCD display enters the idle screen.

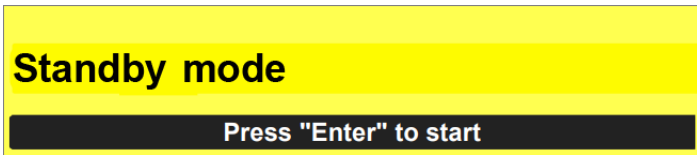

Idle Screen

When the unit is not performing any function, the idle screen is displayed with the following information shown on it:

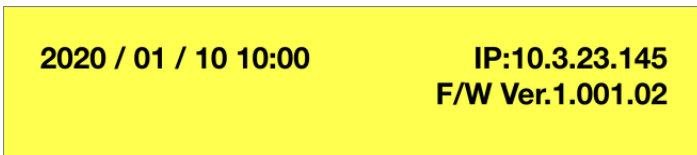

- ◆ **Date & Time**
The current date and time. You can change the setting through the Video Wall Processor Web GUI.
- ◆ **IP Address**
The IP address of this unit. Open a supported browser on the PC which connects to the network the same with this unit, and enter this IP address to log in to the Web GUI for further configurations.

- ◆ Firmware Version

The current firmware version installed on the unit. To upgrade the firmware, please go to the main menu screen > F/W upgrade. See *F/W upgrade*, page 56 for details.

When the LCD display is locked, a lock icon is displayed on the upper-left corner of the screen. To leave the locked idle screen, follow the on-screen instruction to press any button to start, enter your password to continue if a password is required, and finally press the **Enter** button to unlock. If no password is required, simply press any button and then the **Enter** button. See *LCD Password*, page 46, for details.

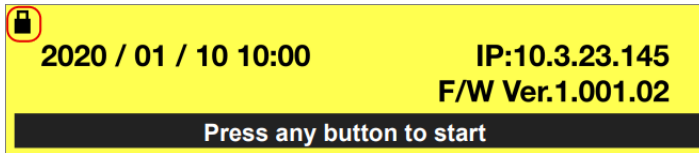

LCD Password

By default, the password protection is disabled. Please press any button to start, and then press the **Enter** button to unlock the LCD display.

If the password protection is enabled, do the following to enter a 4-digit password to unlock the on-screen display:



1. Press any button to start, and you will enter the screen that requires you to enter the password.
2. Input your password using the **Up** or **Down** buttons to cycle through the digits. Once the digit is selected, press the **Enter** button to advance to the next digit.

Note: To clear the current digit and go back to the previous digit, press the **ESC** button.

3. Press the **Enter** button to submit the 4-digit password to unlock the LCD display.

-
- Note:** 1. The Video Wall Processor password can be any four digit combination between 0000 to 9999.
2. If you enter an incorrect password, the Incorrect Password screen shows up. Press the Enter button to return back to the enter password screen and try again.

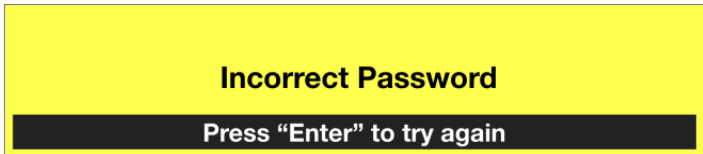

Menu

Press the **Menu** pushbutton to access the main menu screen and use the navigation buttons (the **Up** arrow or the **Down** arrow) to cycle through the menu options as illustrated below:

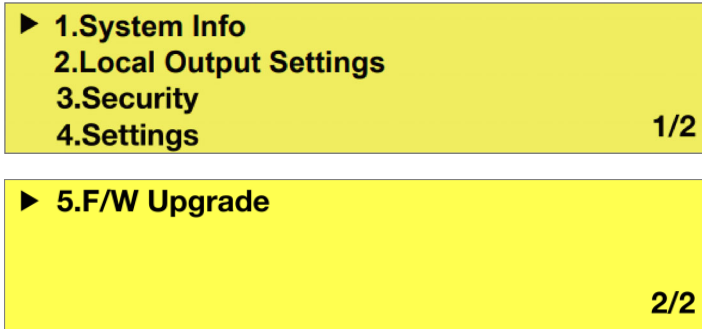

| Menu Option | Description |
|-----------------------|--|
| System Info | Shows the system information of this Video Wall Processor. |
| Local Output Settings | Configures the auto polling function for the HDMI local output. When enabled, the connected display automatically cycles through the four zones at the defined interval. The default setting is Off . |
| Security | Configures the password protection for the LCD display. |
| Settings | Configures the unit's settings of the EDID mode / OSD /network. |
| F/W Upgrade | Upgrades the firmware of the Video Wall Processor through local operation. |

System Info

On the main menu screen, use the navigation buttons to select System Info and press the **Enter** button to enter the system info screen, the following information are listed:

- ◆ IP address
- ◆ Submask
- ◆ Gateway
- ◆ Firmware version
- ◆ Model name
- ◆ Manufacturer

Press the navigation buttons to switch between page 1 and page 2. Press the **Enter** button or the **ESC** button to return back to the main menu screen. To change the unit's IP address, the submask, and the gateway, please go to the main menu screen > Settings > Network. See *Network*, page 54 for details.

Local Output Settings

Configures the auto polling behavior of the system HDMI local output. When auto polling is enabled, the monitor connected to the HDMI local output port cycles through the preview screens of the four display zones at the selected interval (10s / 30s / 60s). This allows the operator to monitor each zone in sequence without manual switching. The default setting is **Off**.

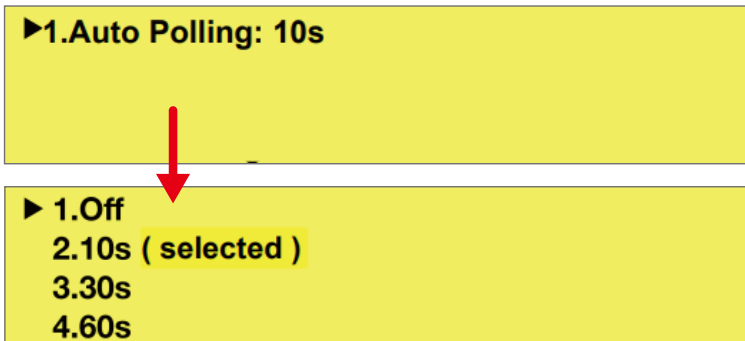

To configure, press the **Menu** button to enter the main menu, use the **Up** and **Down** arrows to highlight Local Output Settings, and press **Enter** to confirm. Use the arrows to select the desired polling interval, then press **Enter** again to apply.

Note:

- ◆ The local output preview is shown on the external display connected to the HDMI local output port, not on the front-panel LCD.
- ◆ Auto Polling is not available in Array Source View.

Security

Enter the submenu of **Security**, and you can further configure the password-related settings for the Video Wall Processor.

- ▶ **1.Mode: Auto Lock with Password**
2.Time out: 1min
3.Change Password

Mode

The Video Wall Processor offers the following three security modes for user to select:

- ▶ **1.Never Lock**
2.Auto Lock
3.Auto Lock with password (selected)

| Mode | Description |
|-------------------------|---|
| Never Lock | The Video Wall Processor's LCD display is not locked and it can be operated by any user. |
| Auto Lock | The Video Wall Processor will automatically locks the LCD display when it has been unlocked for a certain period of time which can be set through the main menu > Security > Timeout . |
| Auto Lock with Password | The Video Wall Processor will automatically locks the LCD display when it has been unlocked for a certain period of time which can be set through the main menu > Security > Timeout . To unlock the LCD display, you need to input the 4-digit password. See <i>LCD Password</i> , page 46. |

Please note that the current selected mode is marked with the word selected.

Timeout

The Video Wall Processor LCD display enters the idle screen (see *Idle Screen*, page 45) after it times out. On the Timeout option screen, select between 1 minute, 3 minutes, and 10 minutes to determine how long the LCD display stays unlocked. The current selected option is marked with the word selected.

Change Password

Follow the steps below to change the 4-digit password for unlocking the Video Wall Processor's LCD display:

1. Enter the old password by using the navigation buttons (the **Up** arrow or the **Down** arrow) to cycle through the digits. Once the digit is selected, press the **Enter** button to advance to the next digit. You can clear the current digit and go back to the previous digit by pressing the **ESC** button.

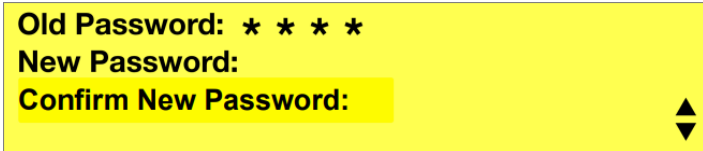

Note: The flashing asterisk (*) indicates the current position that will respond to input the digit.

2. Submit the old password by pressing the **Enter** button, and you will advance to the next step to input your new password.

If the old password you just submitted is incorrect, a warning message as the figure below shows up. Follow the on-screen instruction to press the **Enter** button to go back to the step to input the old password again.

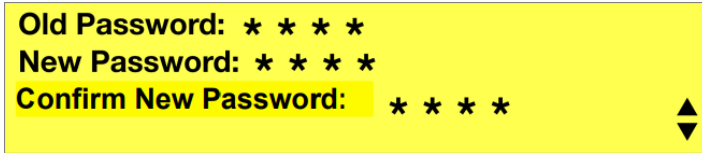

3. Input your new password and then press the **Enter** button to go to the next step to confirm the new password. Confirm the new password by inputting it again and then press the **Enter** button to submit your change.

A yellow rectangular dialog box with a black border. It contains three lines of text: "Old Password: * * * *", "New Password: * * * *", and "Confirm New Password: * * * *". To the right of the "Confirm New Password" line is a small black triangle pointing up and down, indicating a dropdown menu.

Old Password: * * * *
New Password: * * * *
Confirm New Password: * * * *

If the confirm password you input does not match the new password, a warning message shows up. Press the **Enter** button to close the message and return back to the step to input the new password again.

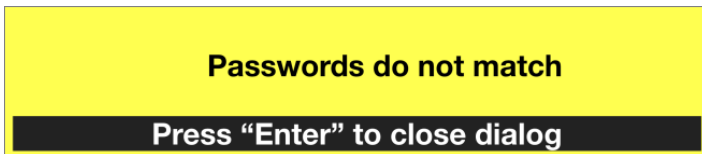
A yellow rectangular dialog box with a black border. It contains two lines of text: "Passwords do not match" and "Press 'Enter' to close dialog".

Passwords do not match
Press "Enter" to close dialog

4. The password is successfully changed. Press the **Enter** button to go back to the main menu screen.

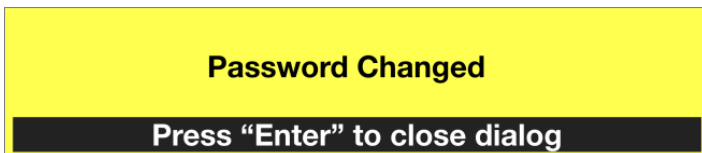
A yellow rectangular dialog box with a black border. It contains two lines of text: "Password Changed" and "Press 'Enter' to close dialog".

Password Changed
Press "Enter" to close dialog

Settings

The baud rate, EDID, OSD, and network features are adjusted from the Settings screen.

Baud Rate

Use the navigation buttons (the **Up** arrow or the **Down** arrow) to cycle through the options and press the **Enter** button to make your selection. The baud rate options are:

- ◆ 9600

- ◆ 19200
- ◆ 38400
- ◆ 115200

Please note that the current selected baud rate is marked with the word selected.

EDID Mode

EDID (extended display identification data) is used to apply a preset video configuration (EDID Mode), which utilizes the best resolution across different monitors. To adjust the EDID mode, do the following:

1. Go to the main menu screen > Settings > EDID Mode.
2. Select the EDID mode from the options:

| EDID Option | Description |
|-------------|---|
| Port 1 | EDID data read from port 1 is passed to all video sources. The system will enforce the Default EDID setting if port 1 is not occupied |
| Default | ATEN's default EDID data is passed to all video sources by default when the system is powered on. |
| Customized | This mode allows user-defined EDID configurations for optimum output. |

Please note that the current selected EDID mode is marked with the word selected.

OSD

The On-Screen Display or OSD feature enables the information about the input source, the output port, and the window(s) to appear on the display device's screen. To configure the OSD settings, do the following:

1. From the Settings screen, use the navigation buttons (the **Up** arrow or the **Down** arrow) to select OSD and press the **Enter** button to access its submenu.
2. Select to enter the option menu of Output ID, Input ID, and Window ID respectively, and choose whether to show or hide the ID. You can set to

reveal or conceal all the 3 ID information at a time by directly selecting Show All or Hide All on the OSD submenu.

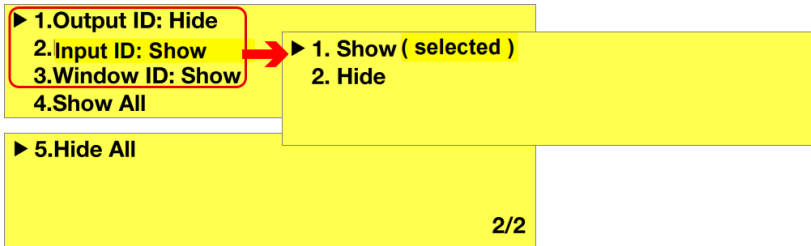

Network

To change the unit's IP address, the submask, and the gateway, do the following:

1. Go to the main menu screen > Settings > Network.

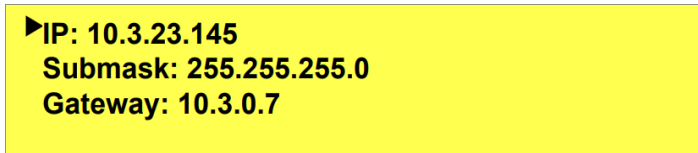

2. Select to access the setting screen of the item to be changed and the screen displays the current IP address / submask / gateway information.

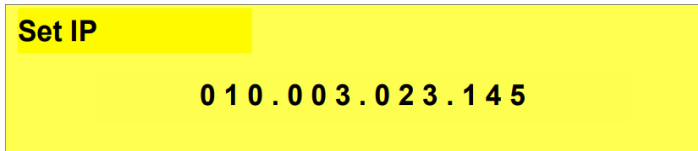

3. The flashing digit identifies the one you are changing. To modify the parameters:
 - ◆ Use the navigation buttons (the **Up** arrow or the **Down** arrow) to cycle through the digits.
 - ◆ Once the digit is determined, press the **Enter** button to advance to the next digit.
 - ◆ Use the **ESC** button to go back to the previous digit without deleting the current one.

- ◆ To return to previous page, press the **ESC** button when editing the first digit, or long press on the **ESC** button when being at any digit position.

Note: 1. The address consists of four decimal numbers whose range is from 0 to 255, and the first digit of each decimal numbers only ranges from 0 to 2.

2. If the numbers you configured exceeds the limitation of 255, it will be automatically modified to be 255.
 3. If the address you set starts with 000, it will be automatically modified to be 001.
-

4. After all the four numbers are determined, press the **Enter** button to submit your change, and a confirmation screen appears. Use the navigation buttons to select the option Save your changes and then press the **Enter** button to continue.

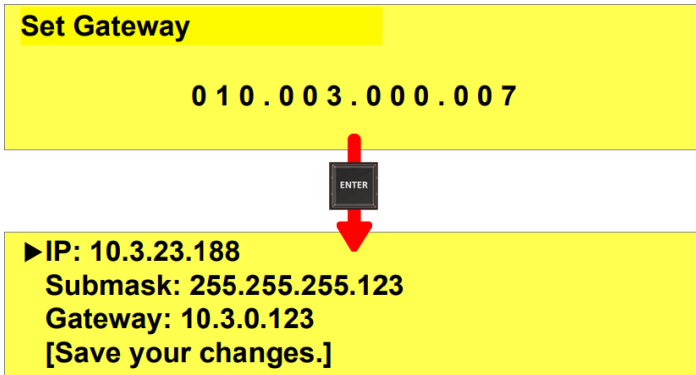

5. Press the **Enter** button again to close the dialog that reminds you the change is saved and return to the Network screen.

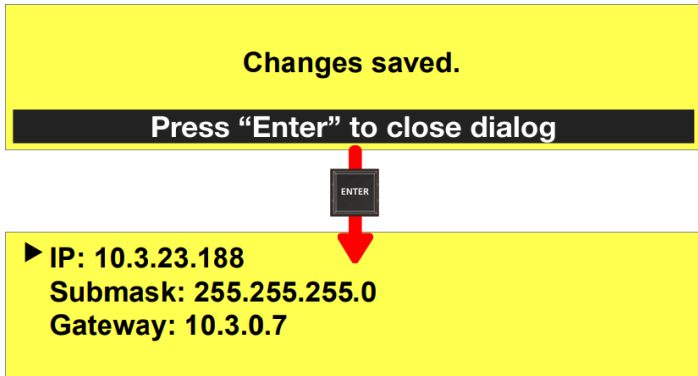

F/W upgrade

To upgrade the firmware of the video wall processor through local operation:

1. Connect a USB drive which contains an up-to-date firmware file to the USB port on the rear side of the unit. See *USB Type-A ports*, page 17.
2. Access the main menu screen > F/W Upgrade. Press the **Enter** button to load the firmware file from the connected USB drive.

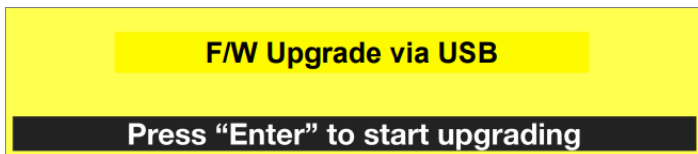

3. The unit starts to load the firmware file and detect whether the firmware version is valid.
 - ◆ If the firmware file is invalid, a message screen shows up to remind you to check the firmware file. Simply press the **Enter** button to close

the dialog and try again.



- ◆ If the firmware file is detected and confirmed valid, the unit starts to upgrade its firmware. During the upgrade process, do not power off the Video Wall Processor.

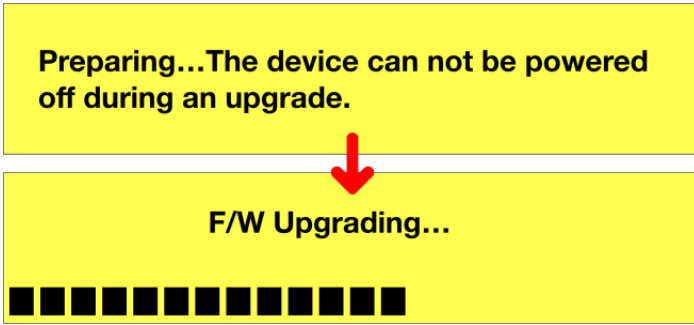

4. Once the upgrade is completed, the LCD display shows the message as illustrated below. Press the **Enter** button to return to the unlocked idle screen.

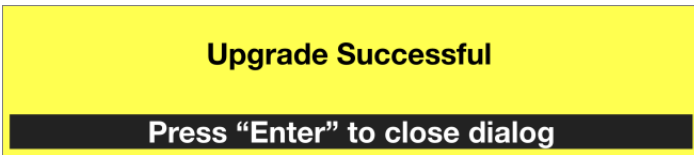

Local Output

The **Local Output** pushbutton enables real-time monitoring of input sources and video wall layouts through a display connected to the system's HDMI local output port.

Note: The illustrations in this section use the VW3620 as an example. The Local Output operation is the same on the VW1608.

Press the **Local Output** button to cycle between the following view modes:

- ◆ **Zone View:**
Displays the video wall by zone. Use the navigation keys to switch between Zone A, B, C, or D.
- ◆ **Single Source View:**
Displays a selected input source. Use the navigation keys to switch between different sources.
- ◆ **Array Source View:**
Displays all connected input sources in an array preview.

The last selected view mode is retained and will be restored the next time the **Local Output** function is used.

Press the **Local Output** button, and the LCD display shows the current selected mode and its related feature options as illustrated below:

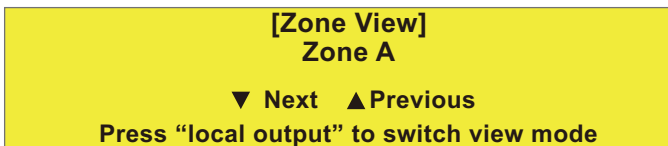

| Item | Description |
|----------|---|
| [Mode] | Shows the current mode (Zone View / Single Source View / Array Source View). |
| Next | Switch to the next zone or video source. Please note that this function is unavailable in Array Source View. |
| Previous | Switch to the previous zone or video source. Please note that this function is unavailable in Array Source View. |

Zone View

Zone View provides multiple display modes for monitoring video wall zones and outputs. Depending on the system setup, you can preview a single zone, the full cascaded layout, or independent outputs. By selecting Zone View, the output is displayed according to the selected mode. Use the **Next / Previous** navigation buttons and press **Enter** to cycle between zones. The duration each zone is displayed can be defined through the menu function Auto Polling. See *Local Output Settings*, page 49 for details.

Zone View includes the following display modes:

Zone View (Video Wall Mode)



Displays the selected video wall zone (A / B / C / D).

- ◆ Use the navigation buttons to switch between zones.
- ◆ Shows the assigned input sources for each window within the zone.

Zone View – Cascade (Video Wall Mode)

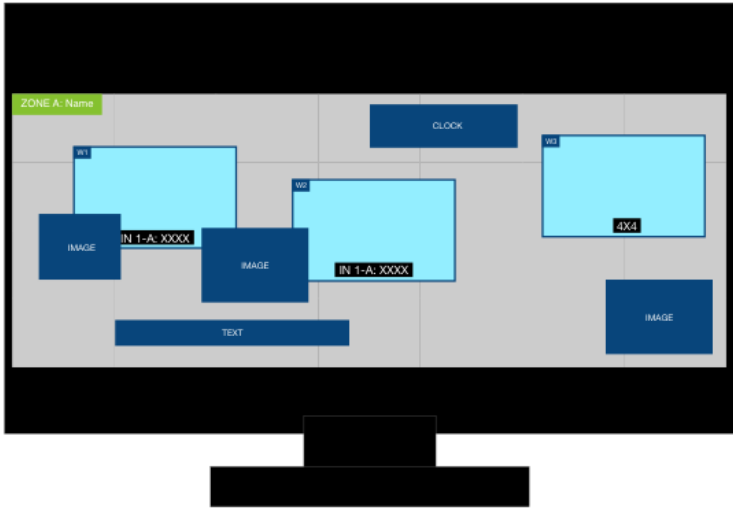

Displays the entire cascaded video wall layout.

- ◆ Each window shows its assigned input source number.
- ◆ Gray borders indicate the output frame boundaries.

Zone View (Independent Mode)



- ◆ Displays the output-to-input mapping information of the selected zone in text format.
- ◆ Shows the zone name and the mapping between output ports and their corresponding input sources.
- ◆ Each entry indicates which input port is assigned to a specific output port.

- ◆ Format:

ZONE <Zone Name>

OUT <Output Port>: IN <Input Port>

- ◆ Example:

ZONE B: XXXXX

OUT 1-A: IN 1-B

- ◆ Where:

- ◆ ZONE indicates the currently selected zone.
- ◆ XXXXX is the user-defined zone name.
- ◆ OUT refers to the output port.
- ◆ IN refers to the input port.
- ◆ Port numbers (for example, 1-A, 1-B) represent the physical port identifiers on the device.

Note: In Independent Mode, Zone View presents zone mapping information in text format to clearly indicate the relationship between output ports and input sources.

Zone View – Cascade (Independent Mode)

```

ZONE B: XXXXX
C1 OUT 1-A: IN 1-A   C2 OUT 1-A: IN 1-A   C3 OUT 1-A: IN 1-A   C3 OUT 4-D: IN 4-A
C1 OUT 1-B: IN 1-B   C2 OUT 1-B: IN 1-B   C3 OUT 1-B: IN 1-B   C3 OUT 5-A: IN 1-B
C1 OUT 1-C: IN 1-C   C2 OUT 1-C: IN 1-C   C3 OUT 1-C: IN 1-C   C3 OUT 3-B: IN 1-C
C1 OUT 1-D: IN 1-D   C2 OUT 1-D: IN 1-D   C3 OUT 1-D: IN 1-D   C3 OUT 5-C: IN 1-D
C1 OUT 2-A: IN 1-A   C2 OUT 2-A: IN 1-A   C3 OUT 2-A: IN 1-A
C1 OUT 2-B: IN 1-B   C2 OUT 2-B: IN 1-B   C3 OUT 2-B: IN 1-B
C1 OUT 2-C: IN 1-C   C2 OUT 2-C: IN 1-C   C3 OUT 2-C: IN 1-C
C1 OUT 2-D: IN 1-D   C2 OUT 2-D: IN 1-D   C3 OUT 2-D: IN 1-D
C1 OUT 3-A: IN 1-A   C2 OUT 3-A: IN 1-A   C3 OUT 3-A: IN 1-A
C1 OUT 3-B: IN 1-B   C2 OUT 3-B: IN 1-B   C3 OUT 3-B: IN 1-B
C1 OUT 3-C: IN 1-C   C2 OUT 3-C: IN 1-C   C3 OUT 3-C: IN 1-C
C1 OUT 3-D: IN 1-D   C2 OUT 3-D: IN 1-D   C3 OUT 3-D: IN 1-D
C1 OUT 4-A: IN 1-A   C2 OUT 4-A: IN 1-A   C3 OUT 4-A: IN 1-A
C1 OUT 4-B: IN 1-B   C2 OUT 4-B: IN 1-B   C3 OUT 4-B: IN 1-B
C1 OUT 4-C: IN 1-C   C2 OUT 4-C: IN 1-C   C3 OUT 4-C: IN 1-C

```

- ◆ Displays the output-to-input mapping information of the selected zone in cascade mode.
- ◆ Displays the mapping information of all cascaded units within the selected zone.
- ◆ Mapping information is shown in text format only.
- ◆ Each entry indicates which output port on a specific cascaded unit is mapped to which input port.
- ◆ Up to 4 rows are displayed. Each row shows up to 15 output entries.
- ◆ The preview does not display video content.
- ◆ Format:

```
ZONE <Zone Name>
```

```
C<Device No> OUT <Output Port>: IN <Input Port>
```

- ◆ Example:

```
ZONE B: XXXXX
```

```
C1 OUT 1-A: IN 1-A
```

```
C2 OUT 1-B: IN 1-B
```

```
C3 OUT 1-A: IN 1-A
```

- ◆ Where:

- ◆ ZONE indicates the currently selected zone.
- ◆ XXXXX is the user-defined zone name.
- ◆ C<Device No> indicates the cascaded unit number.
- ◆ OUT refers to the output port on the specified cascaded unit.

- ◆ IN refers to the input port mapped to that output.
- ◆ Port numbers (for example, 1-A, 1-B) represent the physical port identifiers.

Note: 1. In cascade mode, Zone View displays mapping information only.
2. Video preview is not available.

Single Source View

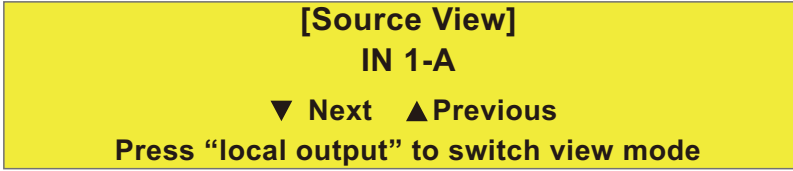

In **Single Source View**, the output screen displayed on the monitor connected to the system HDMI local output port shows a single selected input source. The interface is similar to the figure below:

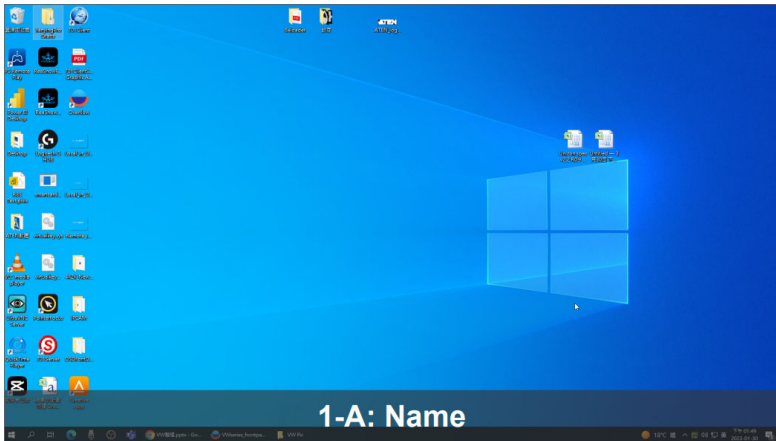

- ◆ Use the navigation buttons (**Next / Previous**) to switch between input sources.
- ◆ The selected input source is labeled with its port number and name (e.g., IN 1-A: Name).

If another platform (such as the Web GUI or Mobile App) is already using **Single Source View**, the local HDMI output will display an OSD message: “Unable to display the source view that is in use by others.”

When the other platform releases the view, the local display will automatically return to the previously selected source screen.

Array Source View

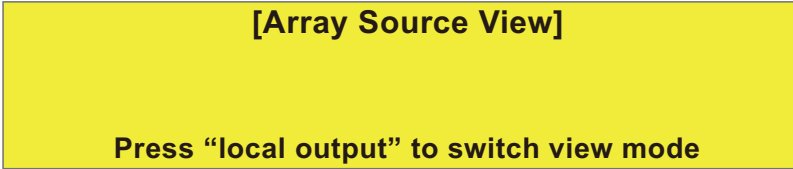

In **Array Source View**, it displays all your input video sources:



Profile

A profile is a set of settings that defines the input to output connections and configured by users in Video Wall Processor Web GUI.

▶ **Zone A: P1**
Zone B: - -
Zone C: P4
Zone D: P3

Press the **Profile** pushbutton to enter the Profile menu, and select the zone to preview using the navigation buttons and the **Enter** button. The LCD panel displays a list of profiles. Use the navigation buttons to cycle through the profiles, and press the **Enter** button to apply the selected profile.

▶ **P1 (selected)**
P3
P4
P5 1/3

Depending on the arrangement of the display monitors you configured for your zone(s) in the Video Wall Processor Web GUI, the preview screen shows on the display device connected to the unit's system HDMI local output port may as the following:

- ◆ **Video Wall**



Independent Display



Chapter 4

Browser Operation

Overview

The Video Wall Processor can be configured over a standard TCP/IP connection via its built-in Graphical User Interface (GUI). Because it can be accessed from anywhere over a network or the Internet, operators can easily log in via web browser. Security is ensured by password protection and user-configurable time-out. For full details see the sections that follow.

Note: All screenshots and illustrations in this chapter use the VW3620 as an example. Web GUI operations and functionality are identical on the VW1608.

Logging In

To access the Web GUI, type the Video Wall Processor's IP address into the address bar of any browser. If a Security Alert dialog box appears, accept the certificate—it can be trusted. The login screen appears:

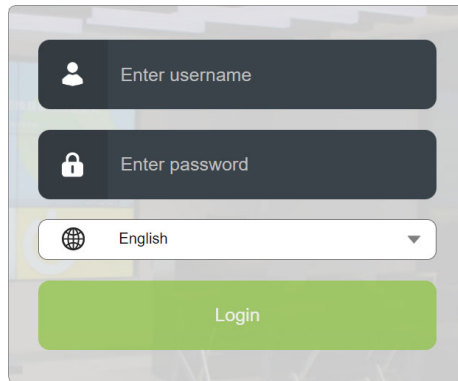

- ◆ For DHCP environment, download IP Installer from ATEN website to your PC and run the IP Installer to get the IP address to log in to the Web GUI.
- ◆ If DHCP is disabled, use the default IP address *192.168.0.60*
- ◆ The default login credentials are *administrator* and *password*.

- ◆ Enter the username and password, then click Login.
- ◆ For the very first time you log in to your Video Wall Processor Web GUI, you are required to change the password. Follow the on-screen instruction to complete the change.
- ◆ Use the drop-down menu to select the display language.

Note: If you have installed a redundant CPU board and connected it to the network using an Ethernet cable, the IP address(es) of CPU 1 and CPU 2 might differ. Run *IP Installer* to obtain the DHCP-assigned address(es).

After successfully logging in to your Video Wall Processor Web GUI, you will enter the **Design Mode** tab where you can set up the display zone(s).

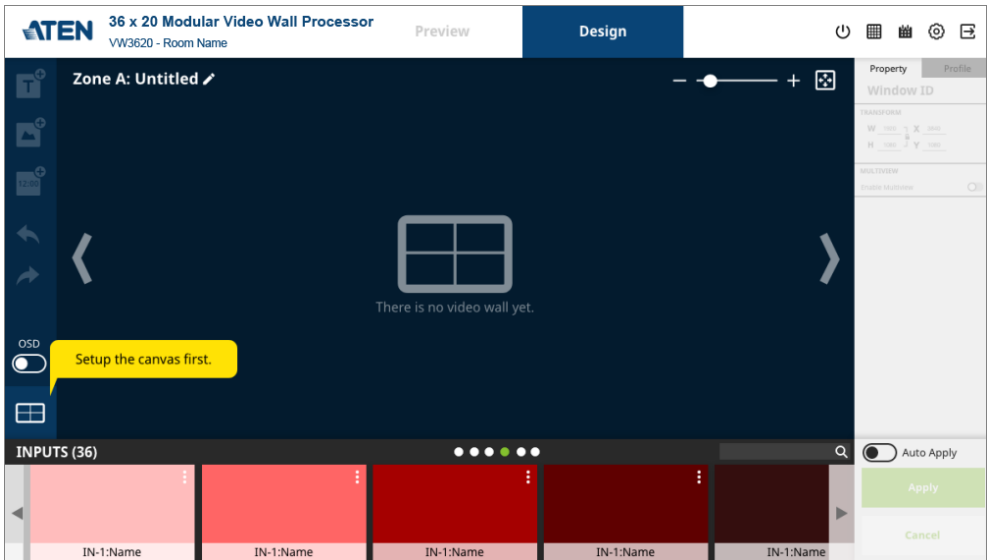



- ◆ **Design Mode:**
Allows you to configure the video wall layout and save it as profiles for convenient switching. See *Design Mode*, page 82 for details.
- ◆ **Preview Mode:**
Lets you review outputs by switching between saved profiles. Video sources and layouts cannot be modified in this mode. Only profile switching is supported. Refer to *Preview*, page 98.

Display Configuration

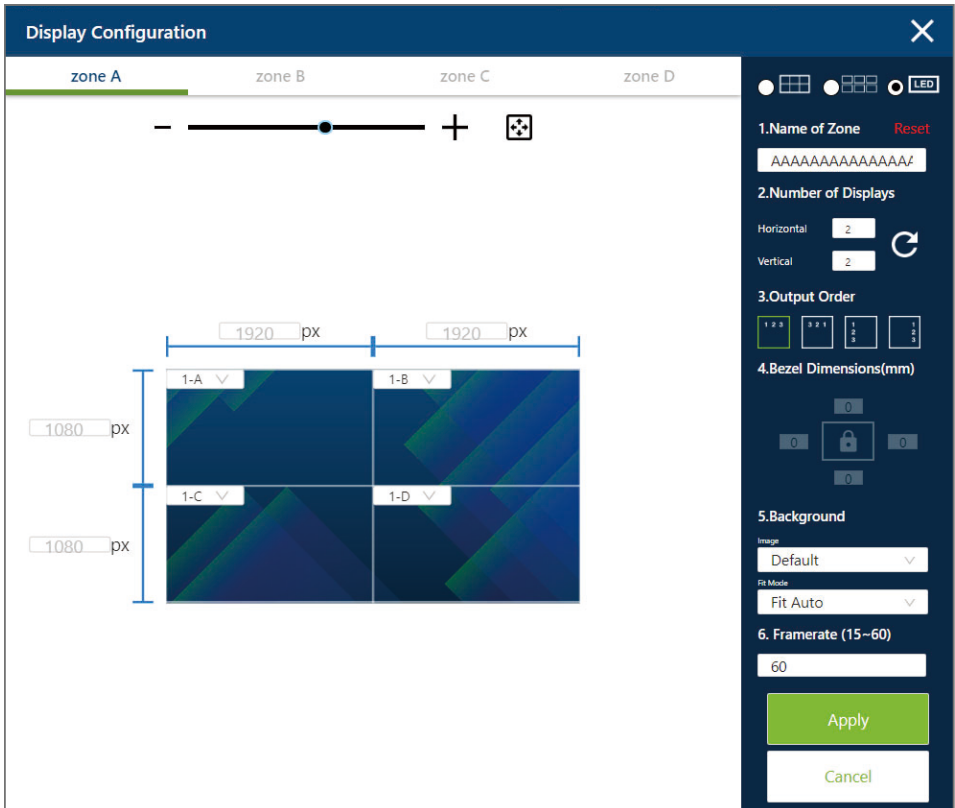
To get started, click on the Display configuration button  to open the popup window to set up your output display configuration.









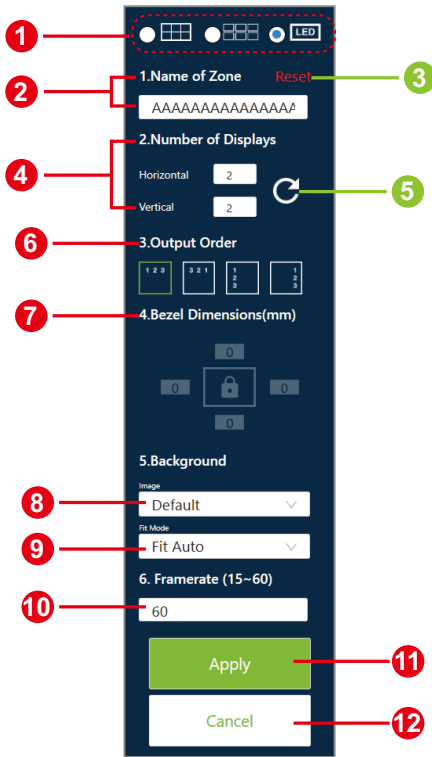

1. Click to select the zone you would like to set up.

- ◆ Use the zoom slider  to change the zoom level of the display zone.
- ◆ Use the zoom to fit button  to automatically resize the display zone to fit the configuration area in this popup window.

2. Configure the display monitors settings in the right panel of the popup window.



| No. | Item | Description |
|-----|---------------------|---|
| 1 | display arrangement | <p>Use the radio button to select the displays arrangement between the options:</p> <ul style="list-style-type: none"> ♦ Video Wall  : Recommended when all output screens share the same size and resolution. ♦ Independent Display  : Uses matrix mode to assign screens and content individually. This mode does not support video wall functionality. ♦ LED mode  : Recommended when the video wall setup includes outputs with different resolutions. |

| No. | Item | Description |
|-----|---|--|
| 2 | name of zone | Define the name for this zone. |
| 3 | reset | Click Reset to clear the settings of number of the displays and the background image. |
| 4 | number of displays | Enter the number of the display monitors belong to this zone. |
| 5 |  apply | Click on the button  to apply the number of display monitors. The video wall layout shown on the configuration area changes subsequently. |
| 6 | output order | Set the output order of the display monitors. |
| 7 | bezel dimensions | Set the bezel (the borders around the screen) in millimeter. Note: The function is only applicable to Video Wall  . |
| 8 | background image | Choose the background image from the drop-down menu. By selecting Upload , you can browse the background image to be uploaded from your PC. Note: The function is inapplicable to Independent Display  . |
| 9 | fit mode | Choose a fit for the background image. <ul style="list-style-type: none"> ◆ Scale to Whole: Makes the background image fit the entire video wall screen. Please note that it may result in the background image being distorted. ◆ Fit Height: Fits the background image to the height of the video wall screen. ◆ Fit Width: Fits the background image to the width of the video wall screen. ◆ Auto Fit: Automatically selects the optimal side to scale to the background image to its maximum size without causing distortion. Note: The function is inapplicable to Independent Display  . |

| No. | Item | Description |
|-----|-----------|--|
| 10 | framerate | Enter the frames per second (fps) to define how many still images or frames are displayed in a single second of video or animation. The available value ranges from 15 fps to 60 fps. Note: The function is only applicable to LED mode LED . |
| 11 | Apply | Click on the Apply button to complete your settings. |
| 12 | Cancel | Click on the Cancel button to close the popup window without saving any change. |

3. Edit the display zone in the configuration area:

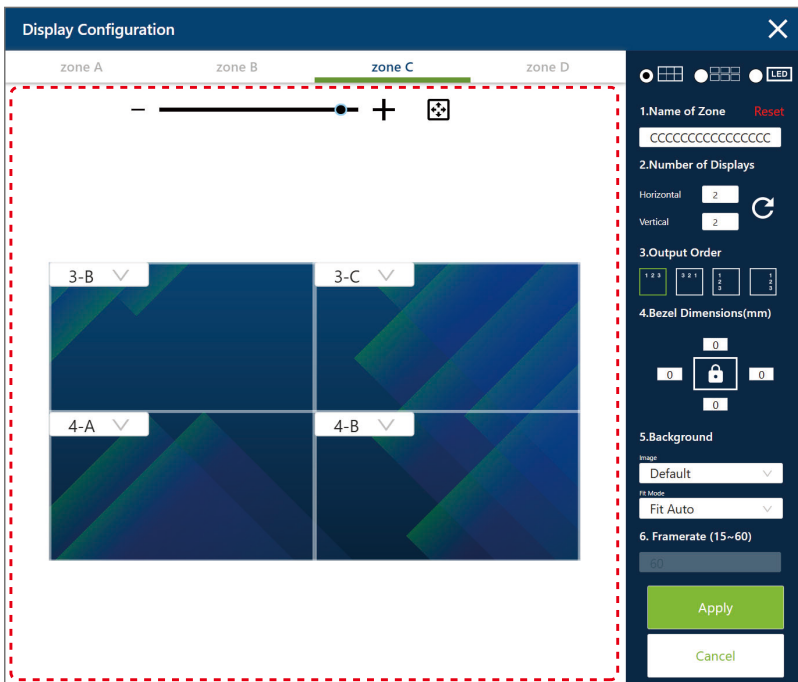

- ◆ From the drop-down menu, select the input video source for each display monitor belongs to this zone.

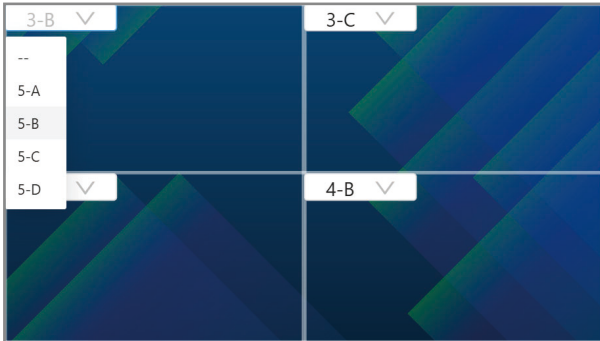

- ◆ By selecting LED mode, you can define the resolution.

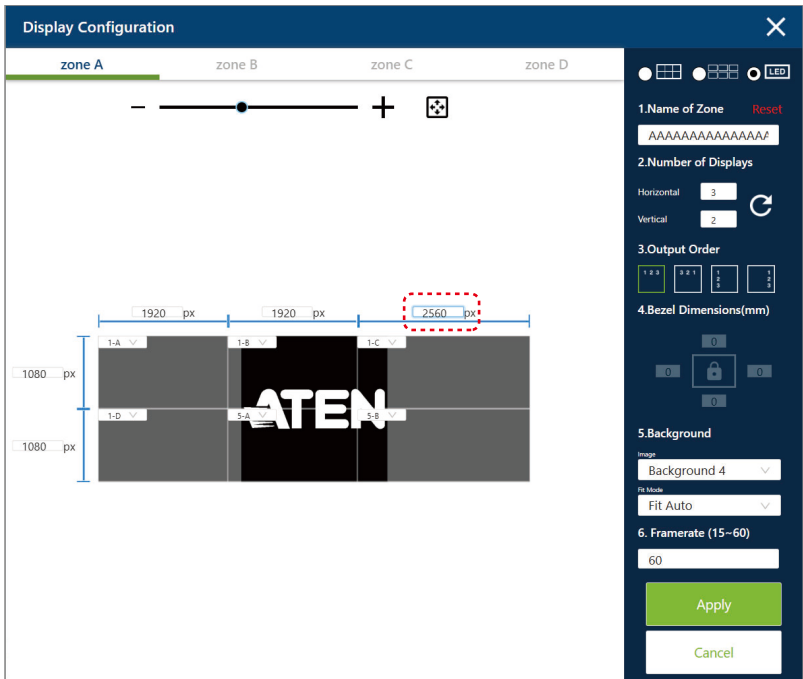

- a) All outputs in LED mode must use the same resolution for both horizontal and vertical displays.

- b) Output resolution for LED mode is configured here. The corresponding zone's resolution settings in the **Settings > Scaler Resolution** page will be disabled.

The further configuration can be proceeded in the **Design Mode** tab.
See *Design Mode*, page 82.

Design Mode – Landing Page After Login



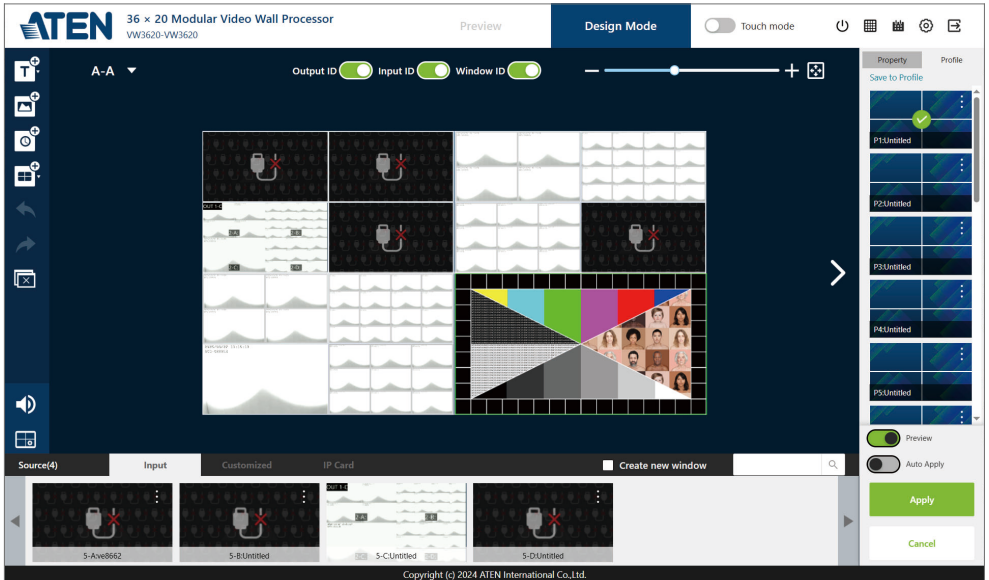

After logging in, you will be directed to the **Design Mode** tab of the Video Wall Processor Web GUI.

This is the landing page of the interface and is divided into three parts—the menu bar (page 76), the **Design Mode** tab (page 82), and the **Preview** tab (page 98).



Menu Bar

Use the buttons in the menu bar to perform the following actions:

| Button | Control | Description |
|---|--------------|--|
|  | Standby | Click to set the Video Wall Processor to standby mode. |
|  | Source Array | Click to set view all the video sources simultaneously. |
|  | Scheduling | Click to enter the page to set the profile playlists that play periodically on specified time frames. |
|  | Settings | Click to access the system settings. Note: This function is only available for the user role, administrator. |
|  | Logout | Click to log out of the Video Wall Processor Web GUI. |

Setting the Standby Mode

The standby mode is a low-power mode where the Video Wall Processor operates minimally by stopping all input and output transmissions and logging the user out of the Web GUI.

To enable the standby mode, click on the **Standby** button from the menu bar in the Video Wall Processor Web GUI.

To disable the standby mode, do one of the following:

- ◆ Press the **Enter** pushbutton from the device panel. See *Standby Mode*, page 45.

- ◆ Log in to the Web GUI with a valid credential, and wake up the unit by clicking on the screen as illustrated below.

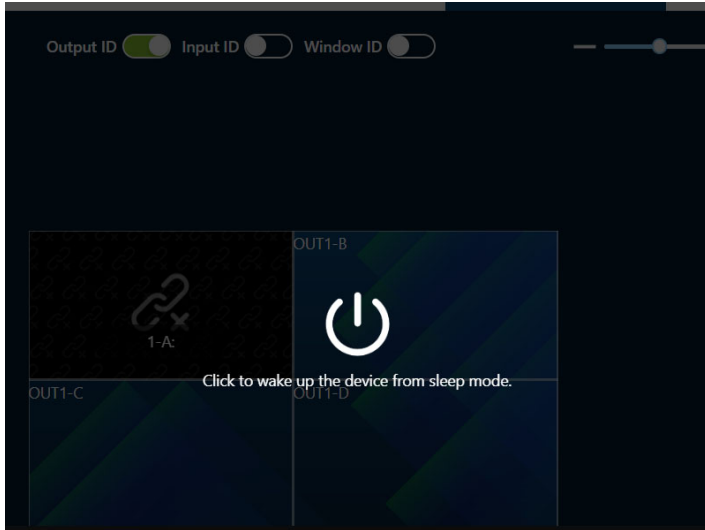

Source Array

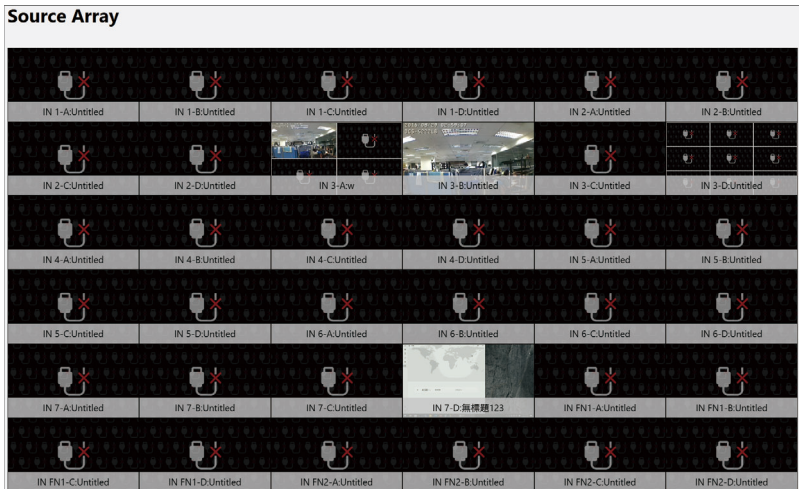

Source Array page displays all the video from the connected input source device(s), giving you a glance at all the video source(s) with the input board numbers, the port numbers, and the self-defined port names.

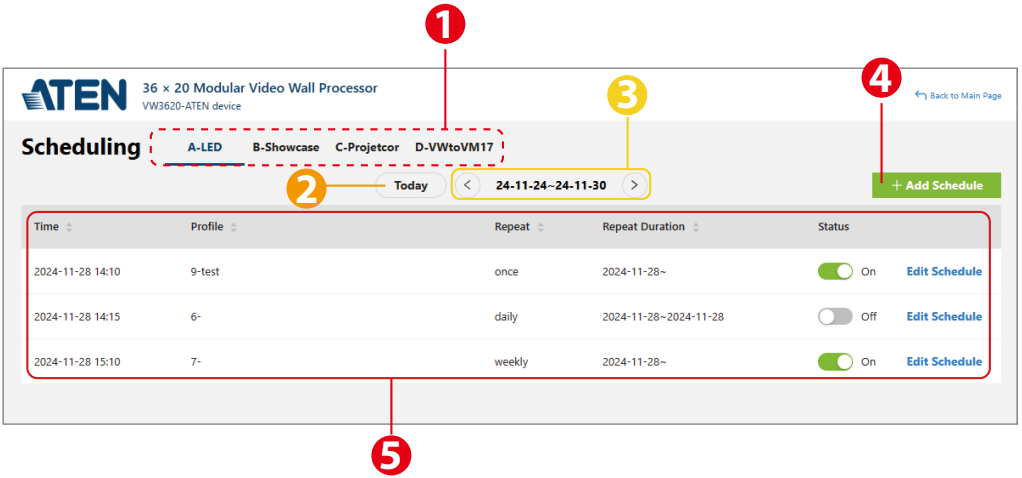

Scheduling

Scheduling helps you to set up tasks that perform automatically on specific days and times.



| No. | Item | Description |
|-----|--------------------|--|
| 1. | zone tabs | Click on a tab to check or manage the task(s) to be performed in this zone. |
| 2. | go to today button | Click on the today button to go back to the current week. |
| 3. | date picker | Click on the next button  or the previous button  to select the range of dates by week view to display the task(s) to be performed within the week. |
| 4. | add schedule | Click to create a new scheduled task for the current zone. |
| 5. | task list | Shows the scheduled task(s) to be performed in this zone during the selected week. |

Create a Scheduled Task

To create a scheduled task, do the following:

1. Open a zone schedule from the zone tabs.
2. Click on the **+ Add Schedule** button to open the add schedule window.

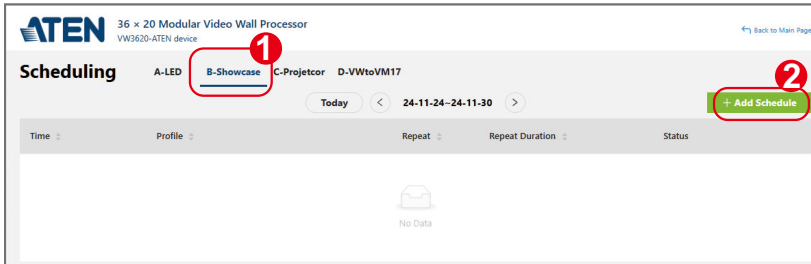

3. Define the following settings:

Add Schedule
✕

Select Profile

7- ▾

Start Time

2024-11-22 📅

15:16 ⌚

Repeat

once ▾

Status On

Cancel
Save

| Item | Description |
|----------------|--|
| Select Profile | Select a profile for this task to play. See <i>Profile Management</i> , page 95 for how to manage the profiles. |
| Start Time | Sets the date and time the task will begin. |

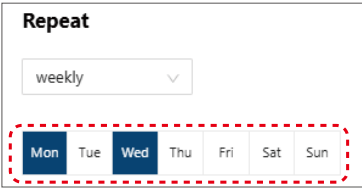
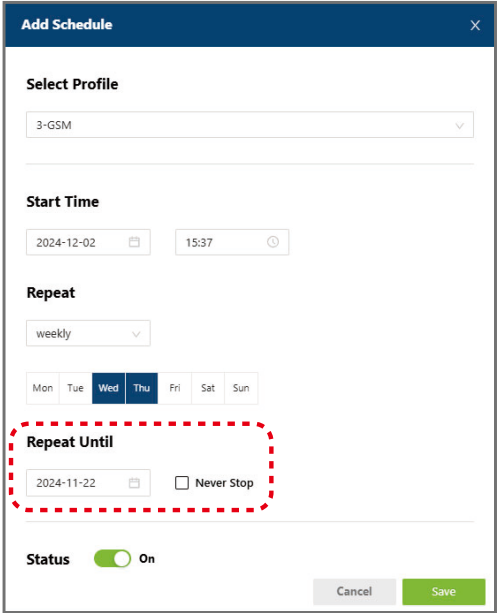
| Item | Description |
|--------------|---|
| Repeat | <p>Performs the task repeatedly at the scheduled times. The options to run the recurring task are:</p> <ul style="list-style-type: none"> ◆ once: The task is executed only one time. ◆ daily: The recurring task is executed everyday. ◆ weekly: The recurring task is executed on a weekly basis. By selecting weekly, you need to further specify the days of the week that the task is run.  |
| Repeat Until | <p>Sets whether end the task on a specified date. This setting is only available when Repeat is set as daily or weekly.</p> <ul style="list-style-type: none"> ◆ Never Stop: Enable this option to continue repeating indefinitely. ◆ Invalid date: Sets the date that the task will no longer run. This option is available when you disable Never Stop.  |
| Status | Click on the switch to turn on or off the task. |

- Click the save button to finalize creating the task. Now you can find the task you just created is on the task list.

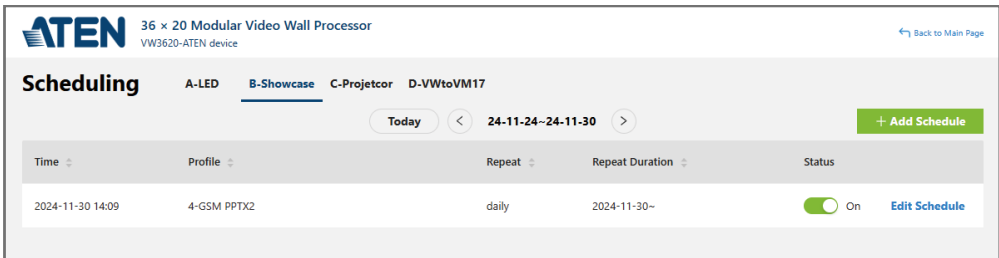

Scheduled Tasks Management

To edit an existing task, find the task you'd like to edit from the task list, and click on its **Edit Schedule** function to open the Edit Schedule popup.

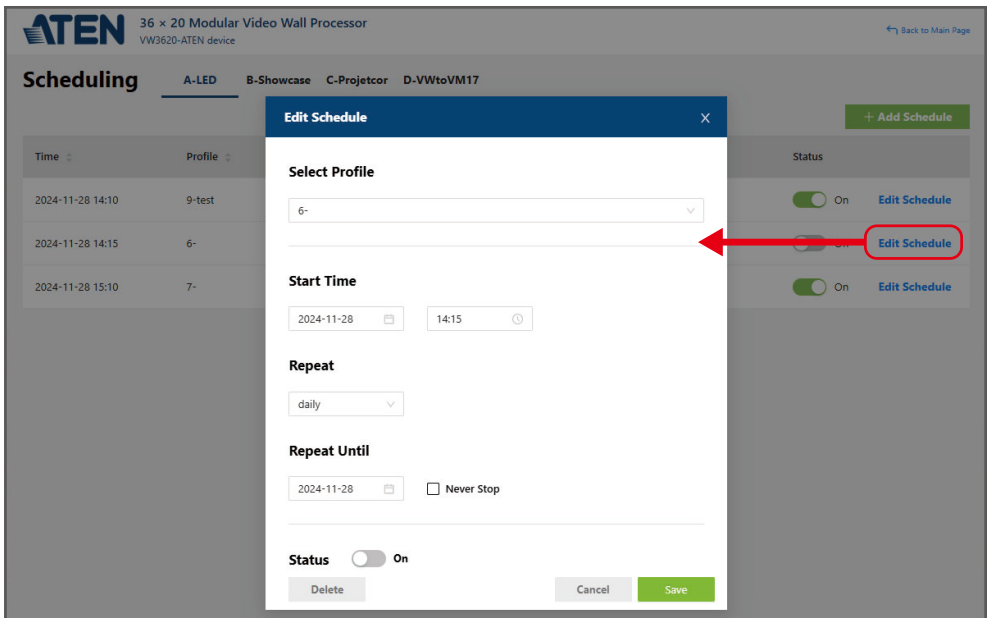

Through Edit Schedule popup, you may:

- ◆ Make changes of this task and save it.
- ◆ Remove this task from the task list by clicking Delete button.
- ◆ Turn on or off the status switch to make this task active or inactive.

Design Mode

Understanding Display Zones

In your video wall processor application, you may more than one video wall set up—for example, a 2 x 2 video wall, a 4 x 4 video wall, and a single-monitor display, all managed by one Video Wall Processor. In this case, you have three display zones.

Understanding Profiles and Profile List

A profile is a set of settings that specifies how video sources will be displayed on one or more video walls. You can create and save your profiles to the Profile List to be conveniently switched via the front panel or the Web GUI.

Interactive Functions on Design Mode Tab

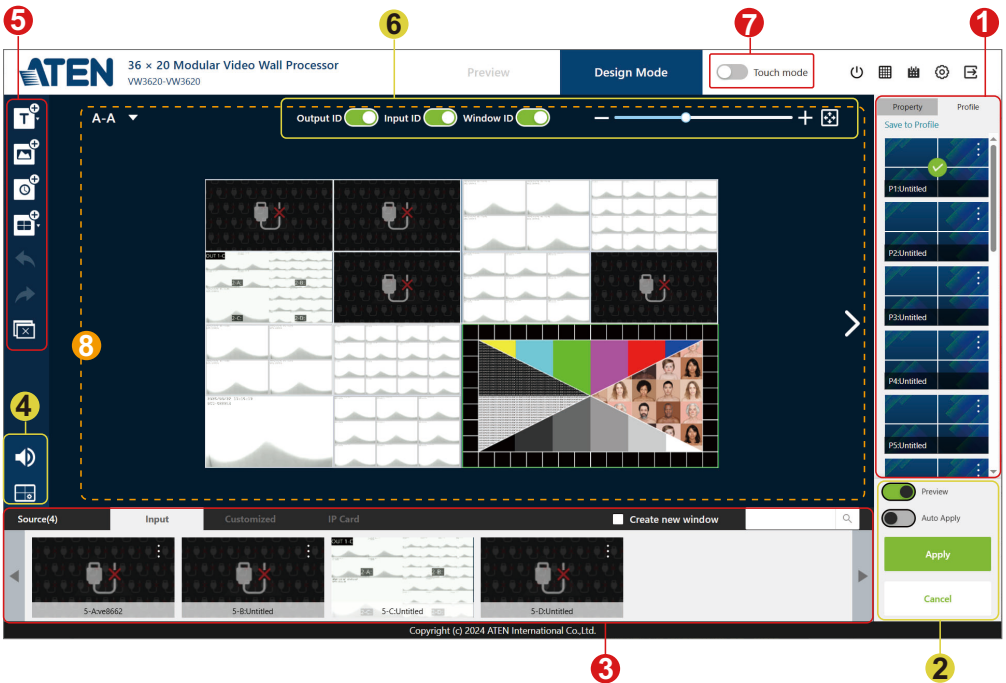

The **Design Mode** tab is where you can configure the video wall layout and save the layout configuration as a profile for conveniently switching. The Design Mode tab contains the following interactive functions:

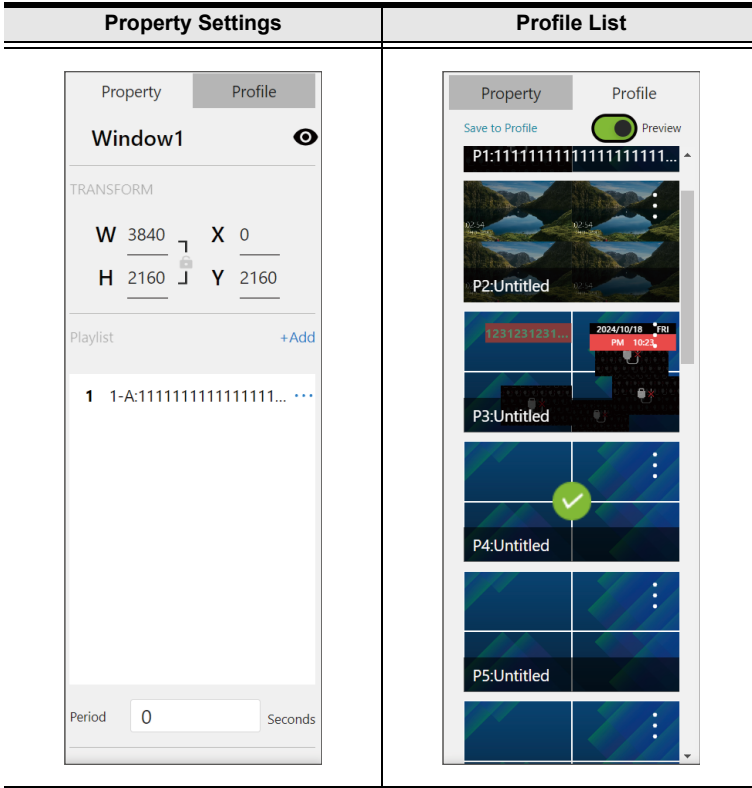

1. Profile Panel

The profile panel contains the following 2 tabs:



- ◆ Profile List:
 - The profile list shows all the profiles, including those are not edited. For details on profile operations, refer to *Profile Management*, page 95.
- ◆ Property Settings:
 - ◆ The property settings tab shows the property of the displayed item(s) in the profile. By selecting an item, the property settings display its property. User can edit the property or click on the show  / hide  button to reveal or conceal the selected item.

- ◆ The **Playlist** function allows you to create and manage a sequence of sources for automatic playback.

| Item | Description |
|---------------------------|--|
| adding a playlist item | Click +Add to insert a new playlist entry. Each entry represents a source that will be included in the playback sequence. |
| editing or deleting items | Use the more button (three dots) next to each entry to open the option menu. From here, you can either Edit the selected source or Delete it from the playlist. |
| playback interval | The Period field at the bottom specifies the playback duration (in seconds). This interval applies uniformly to all entries in the playlist, meaning each source will be displayed for the same amount of time before the system switches to the next one. |

2. Apply Profile Functions

User can determine whether to play the profile shown on the canvas through the functions listed below:

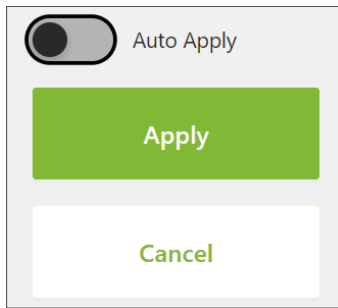





| Item | Description |
|------------|--|
| Auto Apply | Enable the auto apply switch and once you open a profile, it automatically applies to your video wall. |
| Apply | Click on the Apply button to play the profile. |
| Cancel | Discard your changed settings. |

3. Video Source List

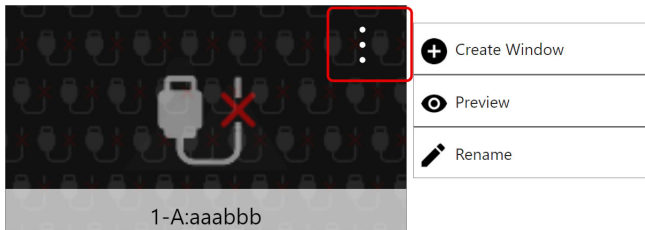
The video source list contains 2 tabs, **Input** and **Customized**. The **Input** tab displays all the input video sources from the connected source devices while the **Customized** tab shows the user-defined video source(s). User can drag and drop the video source to be displayed to the canvas, and release it to the display area to have it placed.





- ◆ To quickly and easily find the video source you need, input the keyword into the search bar, and the video(s) whose input port name fulfills the keyword shows up.
- ◆ By enabling the function **Auto Fit to Frame**, the video automatically scales to fit inside the size of the display frame.
- ◆ By clicking on the more button of a video source (both **Input** and **Customized**), an option menu is opened for you to choose an action to take:

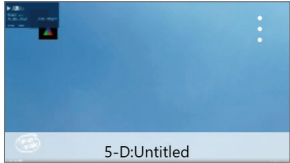

| Action | | Description |
|---|---------------|---|
|  | Create Window | To create a window on the canvas that displays this video source. |
|  | Preview | To open a popup window that display this video source. |
|  | Rename | To rename this video source. |

Note: As to the management of the customized video source, refer to *Multiview Window Management*, page 91.

- ◆ **Source Status Indicators**
When viewing video sources in the Web GUI, the following status icons or overlays may appear to indicate specific conditions:

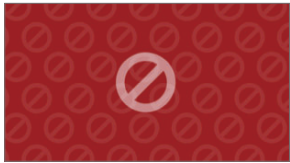
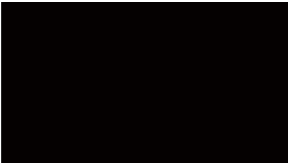
| Source Status | Description | |
|--------------------|--|---|
| | Web GUI Example | Video Wall Example |
| Blank / Disabled |  | |
| | <p>The source is disabled or not displaying content. In the Web GUI, a blank screen is shown with reduced brightness (30%). In Video Wall Independent Mode, the window is not displayed.</p> | |
| HDCP Error |  |  |
| | <p>The connected source is HDCP protected and cannot be displayed. An HDCP warning screen is shown.</p> | |
| No Signal |  |  |
| | <p>The source is disconnected or not receiving input. A “cable unplugged” icon is displayed.</p> | |
| Bandwidth Exceeded |  |  |
| | <p>The input stream exceeds the system’s supported bandwidth. A restriction icon is displayed in the Web UI, and the corresponding window turns black on the Video Wall.</p> | |

4. Audio & Display Configuration Buttons

Click on the Audio Control button











to open the Audio Control popup window for configuring the output audio:

- ◆ Use the drop-down menu to apply options to all output ports.
- ◆ Set for each output port by selecting Mute or the input audio source from the drop-down menu.
- ◆ Click on the Save button to adopt the changed settings.

Click on the Display Configuration button  for arranging the displayed layout for each zone. Refer to *Display Configuration*, page 69 for details.



5. Canvas Toolbar







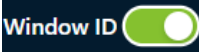

The toolbar contains the 7 tools:

| Item | | Description |
|---|-------------------------|---|
|  | Add Text | Click the button to open the options menu to select whether to add normal text  or to add the scrolling text  . |
|  | Add Image | Click the button to browse the image file to be uploaded. |
|  | Add Clock | Click to open the popup window to configure the details about the clock to be added. |
|  | Create Multiview Window | Click the button to open the option menu to select the window type and open the <i>Multiview Editor</i> popup to edit the input sources. |
|  | Undo | Click the button to reverse the action you just took. |
|  | Redo | Click the button to reverse your last undo action. |
|  | Clear All | Clear all windows and components from the canvas layout. |

6. Layout Configuration Tools

The layout configuration tools offer the following functions:

| Item | Description |
|---|--|
|  | Turn on the Output ID switch to show the output port ID on the display(s). |
|  | Turn on the Input ID switch to show the input port ID on the display(s). |

| Item | Description |
|--|---|
|  | Turn on the Window ID switch to show the window port ID on the display(s). |
|  | The Bring to Front button appears only when an item is selected to be edited. Click on it to bring the selected item to the front of the stack. |
|  | The Bring Forward button appears only when an item is selected to be edited. Click on it to bring the selected item one layer up. |
|  | The Send Backward button appears only when an item is selected to be edited. Click on it to move the selected item one layer down. |
|  | The Send to Back button appears only when an item is selected to be edited. Click on it to send the selected item to the back of the stack. |
|  | The Remove button appears only when an item is selected to be edited. Click on it to delete the selected item. |
|  | The zoom slider is used to zoom in or out the display zone. Drag the slider to change the zoom level. |
|  | Click on the zoom to fit button to change the zoom level and automatically resize the display zone in the canvas area. |

7. Touch Mode Switch

The **Touch Mode** switch adjusts the Web GUI interface for tablet-style operation. When enabled, the interface layout and controls are optimized for touch input, providing a user experience similar to using the Video Wall Processor Web GUI on an Android tablet or iPad.

This mode ensures larger interactive areas and gesture-friendly navigation, making it easier to operate the system on devices without a mouse or keyboard. Most functions are the same as in the standard PC interface, with certain operations adapted for tablet-style interaction.

See *Tablet Control*, page 127.

8. Canvas Area

Canvas area is where you design the display zone. If you have more than one zone, you can easily switch to other zone by the next / previous buttons located on the 2 sides of the canvas, or by selecting the zone name from the drop-down menu.

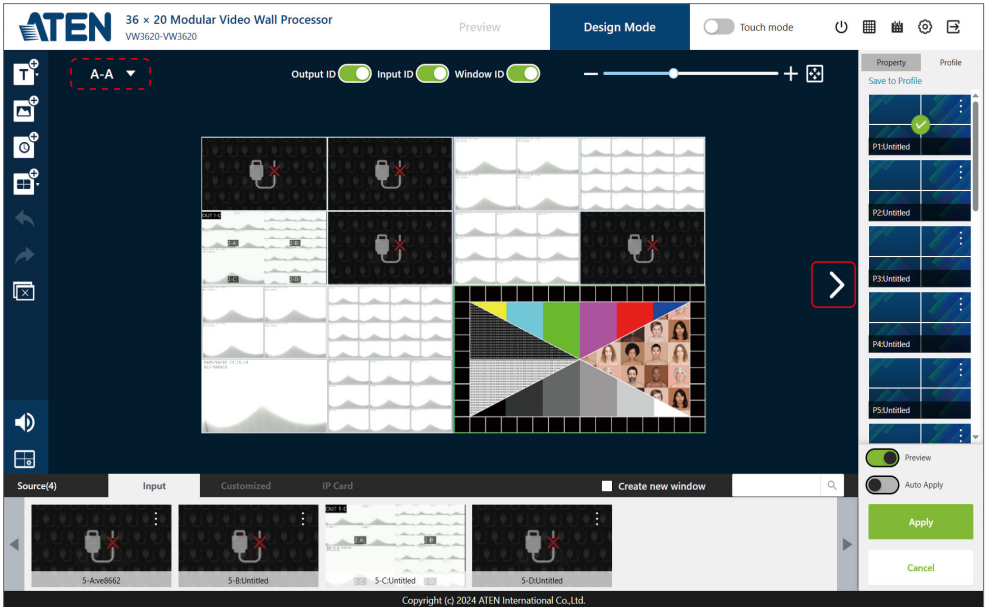

Multiview Window Management

Create a Multiview Window

To create a multiview window, do the following:

1. From the canvas toolbar, click on the **Create Multiview Window** button



to open the option menu to select window type.

2. The **2 X 2 Multiview Editor / 4 X 4 Multiview Editor** popup window shows up. Check the checkbox(es) of the slot(s) to determine which input sources are available for this multiview window.

2 X 2 Multiview Editor

Input Source: Slot 1 Slot 2 Slot 3 Slot 4 Slot 5 Slot 6 Slot 7 Slot FN1 Slot FN2

| | |
|---|---|
| 1 | 2 |
| 3 | |

3. Drag and drop the input source to the layout editing area, and release it to have it placed.

- Click on the **OK** button, and the newly-created multiview window is displayed on the canvas now.

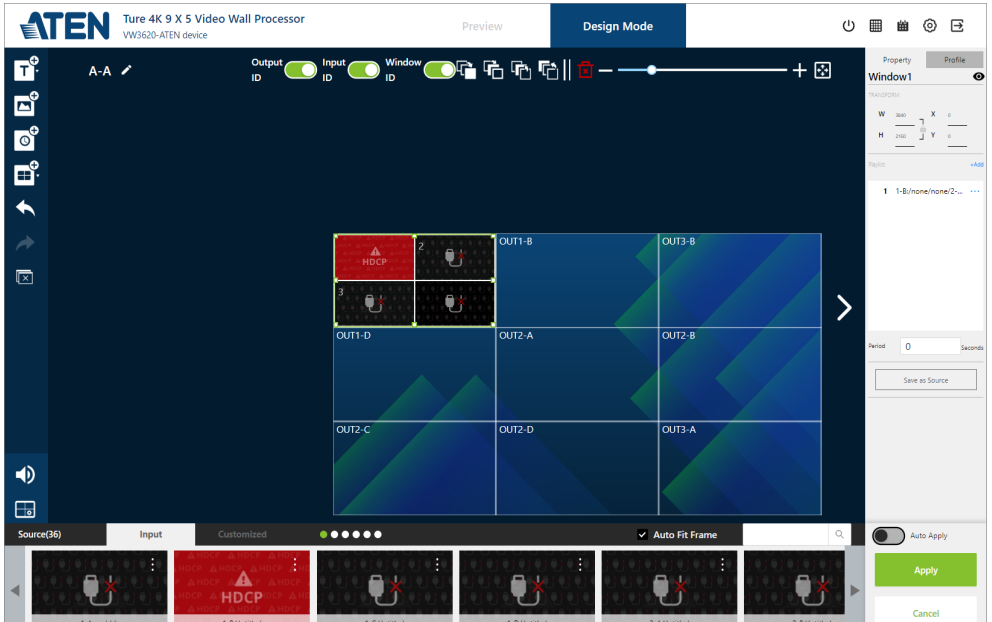

Configure a Multiview Window

To configure an existed multiview window:

1. On the canvas, click to select the multiview window to be edited.
2. From the profile panel, make change of this multiview window's property:

◆Click on the show  / hide

 button to reveal or conceal this window.

◆To resize the window by inputting the width and the height.

◆To move the window, drag and drag the window to place it to your preferred position, or enter the absolute position (x and y coordinates).

◆To add more multiview contents, click on +Add to open a **2 x 2 Multiview Editor** / **4 x 4 Multiview Editor** popup window, and do the following:

a) Check the checkbox(es) of the slot(s) to determine the available input sources.

b) Drag and drop the input source to the layout editing area, and release it to have it placed.

c) Click on the **OK** button to add the multiview content to the playlist.

◆To edit an existed multiview content:

a) Hover the cursor over the more button  next to the multiview content to be edited to expand the option menu.

- b) Select Edit to open the **2 x 2 Multiview Editor** / **4 x 4 Multiview Editor** popup window.

- c) Make change of it and click on the save button to save your changed settings.
- ◆ To remove an existed multiview content from the playlist, hover the cursor to the more button next to the multiview content to be deleted, and select **Delect** from the option menu.
- ◆ Enter the duration that determines how long each multiview content is played.

Customized Video Source

To save a multiview window as a customized video source:

1. On the canvas, click to select the multiview window to be edited.
2. The property tab is shown on the profile panel. Click on the **Save as Source** button to continue.
3. Enter a name fo this customized video source, and then click the **OK** button to create it.

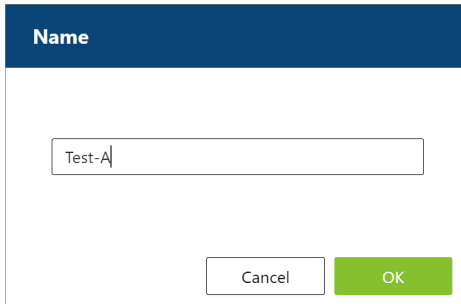

The image shows a dialog box with a dark blue header containing the word "Name" in white. Below the header is a white text input field with the text "Test-A" and a cursor at the end. At the bottom of the dialog box, there are two buttons: a white "Cancel" button and a green "OK" button.

Profile Management

Creating a Profile

To create a profile:

1. Enter the **Design Mode** tab.
2. (Optional) Follow the steps as *Display Configuration*, page 69 describes to set the zone(s) and the display monitors.
3. Use the interactive functions to configure the display zone(s).
See *Interactive Functions on Design Mode Tab*, page 82.
4. Once you finish the layout design, click on **Save to Profile** in the profile panel to open the **Save to Profile** popup.



5. Select a profile item from the drop-down menu and click on the **OK** button to save it.

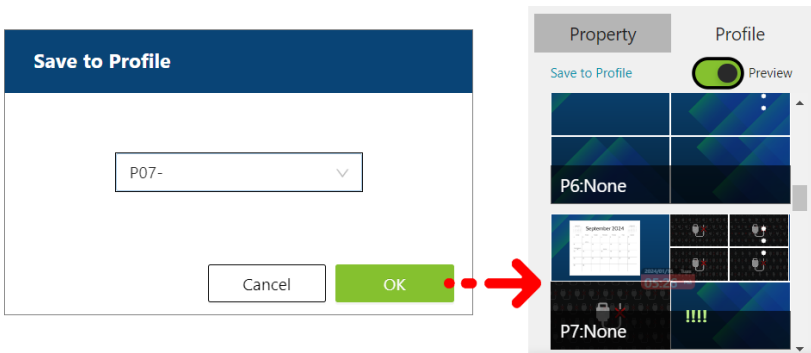

Edit a Profile

To edit an existed profile:

1. Click on the more button  of the profile to be edited to open the option menu, and select **Open**.

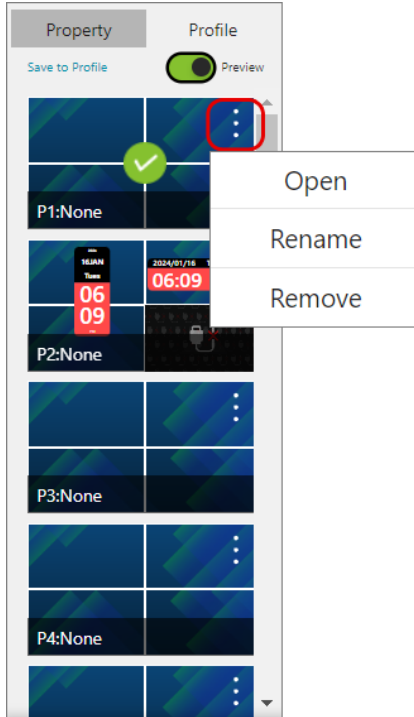

2. The profile is now shown in the canvas area. Use the interactive functions to make change of it, and click on **Save to Profile** in the profile panel to open the popup window. Select the profile item from the drop-down menu, and click the **OK** button to save your change(s).

Apply a Profile

To implement a profile to display the video configuration to the connected output devices, do the following:

1. From the profile panel, click on the more button  of the profile to be played to open the option menu, and then select **Open**. Or drag the profile to be edited to the canvas area and release it to open this profile.

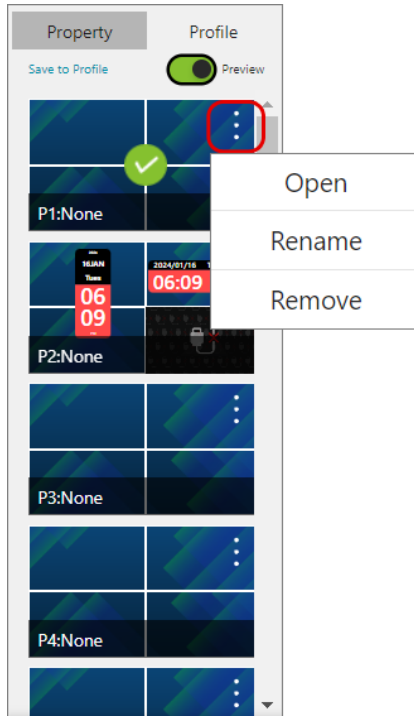

2. Click on the **Apply** button beneath the profile panel to implement the current-opened profile.

Preview

To view the live streaming of the implementing profile output to the display device(s), please go to the **Preview** tab.

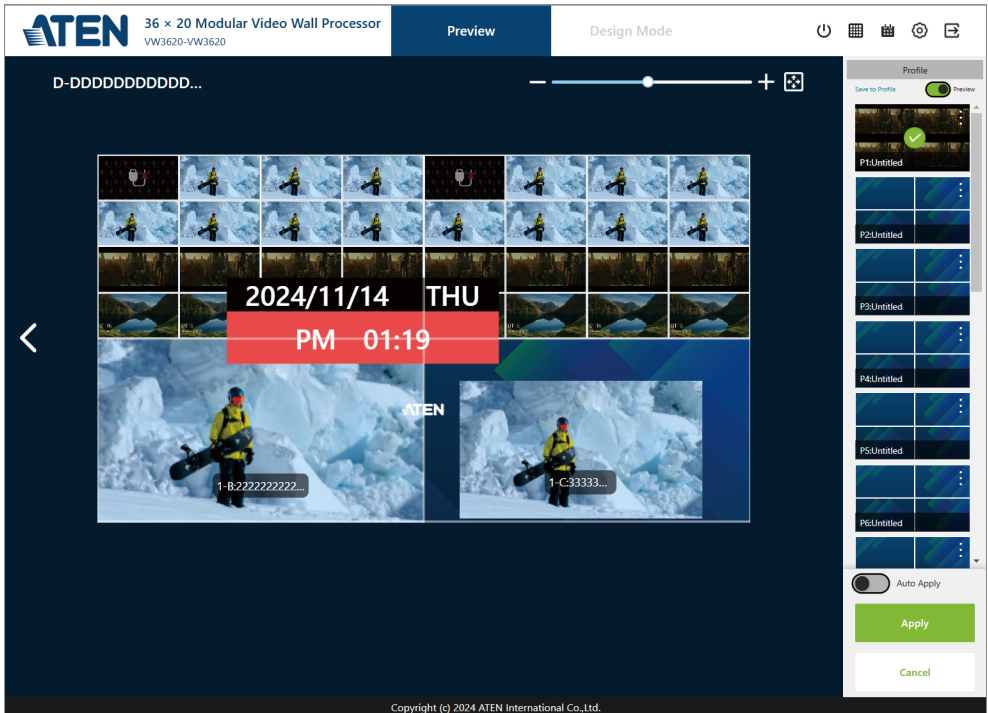



In **Preview** mode, you can review the output by switching between saved profiles. Profiles can be selected from the list on the right by:

- ◆ Clicking the more button on a profile and choosing **Open**.
- ◆ Dragging a profile into the preview window.

Video sources and layout configurations cannot be modified in this mode—only profile switching is supported.

Delete a Profile

To delete an existing profile:

1. From the profile panel, find the profile to be deleted, and click on its more button   to open the option menu.

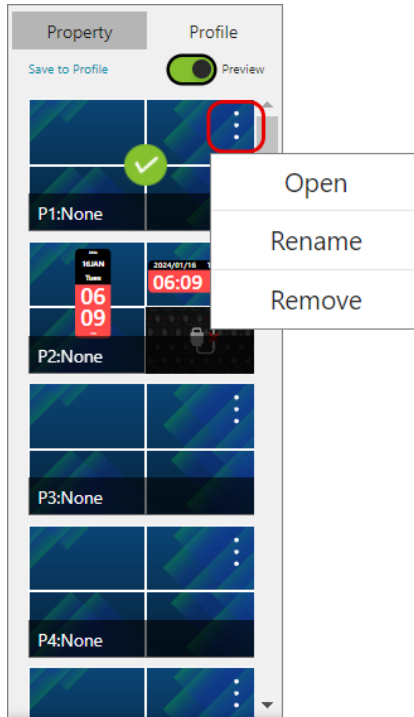

2. Simply select **Remove** to delete the profile, and confirm to delete it. The profile item will be cleaned up.

System Settings

Click on the **Settings** button  in the menu bar to enter the settings page for configuring the system settings. Please note that only the user with administrator user role can access the settings page.

The setting page opens to the **General** tab. To access to other settings, click on the menu item listed in the system settings menu bar, and you will directly to enter its tab page or expand its submenu to select the setting category you'd like to configure.

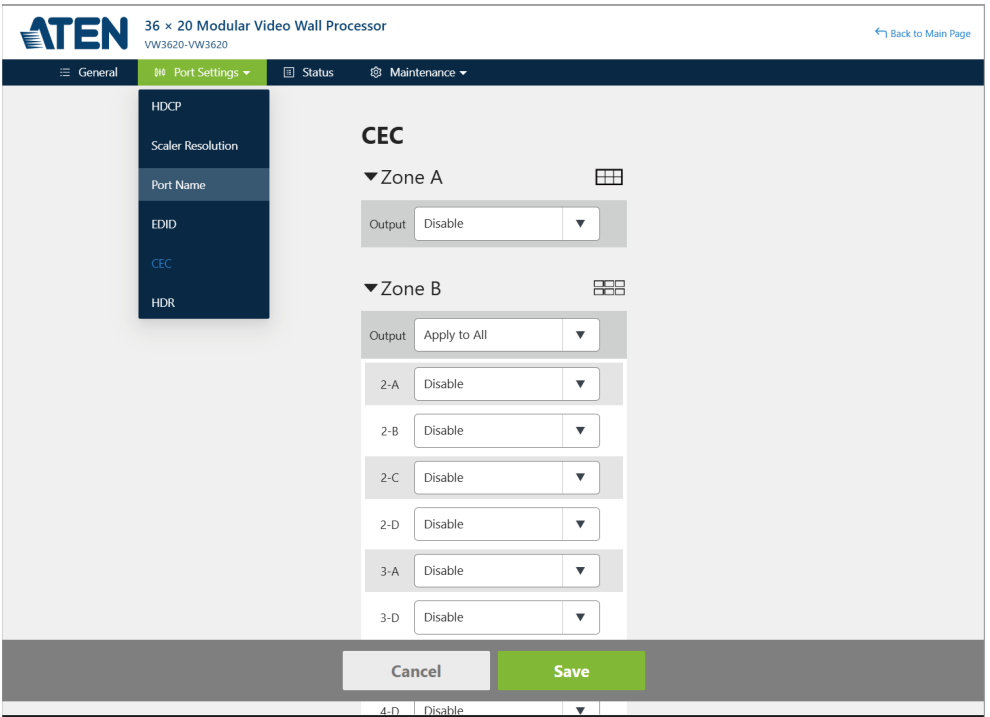

The screenshot displays the ATEN 36 x 20 Modular Video Wall Processor settings interface. The top navigation bar includes the ATEN logo, the model name '36 x 20 Modular Video Wall Processor VW3620-VW3620', and a 'Back to Main Page' link. The main menu has four tabs: 'General', 'Port Settings', 'Status', and 'Maintenance'. The 'Port Settings' tab is active, and a submenu is open showing options: 'HDCP', 'Scaler Resolution', 'Port Name', 'EDID', 'CEC', and 'HDR'. The 'CEC' option is selected, leading to the 'CEC' configuration page. This page is divided into two sections: 'Zone A' and 'Zone B'. 'Zone A' has an 'Output' dropdown set to 'Disable'. 'Zone B' has an 'Output' dropdown set to 'Apply to All', followed by individual dropdowns for ports 2-A, 2-B, 2-C, 2-D, 3-A, and 3-D, all of which are currently set to 'Disable'. At the bottom of the page, there are 'Cancel' and 'Save' buttons. A partially visible dropdown for port 4-D is also shown at the very bottom.

Overview

The table below provides an overview of the available settings for each tab.

| Tab | Supported Functions | Detailed Information |
|---------------|--|--|
| General | <ul style="list-style-type: none"> ◆ Configure the device name. ◆ Select the interface language. ◆ Configure the system time. | For more information, see <i>General</i> , page 102. |
| Port Settings | <ul style="list-style-type: none"> ◆ Configure the CEC port settings. ◆ Configure the HDCP key. ◆ Name the input ports. ◆ Select EDID modes. | For more information, see <i>Port Settings</i> , page 103. |
| Status | <ul style="list-style-type: none"> ◆ Provide a graphical view for user to check statuses of the input/output boards installed to the Video Wall Processor. | For more information, see <i>Status</i> , page 113. |
| Maintenance | <ul style="list-style-type: none"> ◆ Upgrade the firmware for the installed input and output boards ◆ Back up or restore the Video Wall Processor's configuration ◆ Add, edit, or remove user accounts ◆ Configure the system network settings | See <i>Maintenance</i> , page 117. |

General

The **General** tab allows you to configure the following settings:

| Item | Description |
|---------------------|---|
| Device Info | |
| Device Name | Define the name for this unit. |
| Firmware Version | The current version of the firmware installed on this unit. |
| Buad Rate | Select the buad rate from the drop-down menu |
| Language | Select the display language for this unit. |
| System Time | |
| System Time | Set the system time. |
| Time Zone | Set the time zone. |
| NTP Server | Set the Network Time Protocol (NTP) to synchronize the clock between the unit and the server. |
| Sync with PC | To synchronize the time shown on the Video Wall Processor with the connected PC. |

| Item | Description |
|----------------------|---|
| Cancel / Save | By making any changes on this page, the Save button located at the bottom of the page becomes available. Click on it to adopt the changed settings. Click on Cancel to discard the changes. |

Port Settings

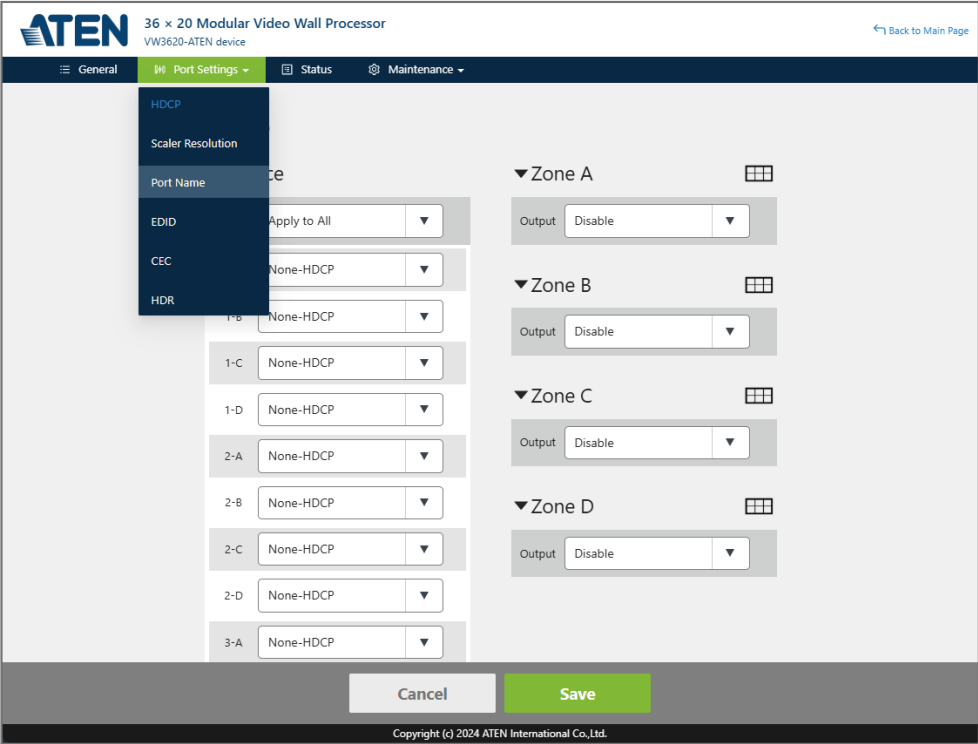

Move the cursor over the menu item **System Settings** to expand the submenu, and click on the submenu option you'd like to configure to enter the page.

HDCP

The **HDCP** (High-bandwidth Digital Content Protection) page allows user to view and set HDCP settings for digital copy protection.

Source Settings

To set HDCP for the input video source(s):

- ◆ Separately set for each input ports by selecting between **HDCP 1.4**, **HDCP 2.2**, and **Non-HDCP** from the drop-down menu.
- ◆ From the Apply to All drop-down menu of the Input field, select the option to be applied to all the input ports at a time:
 - ◆ All Ports HDCP 1.4
 - ◆ All Ports HDCP 2.2
 - ◆ All Ports Non-HDCP

Zone Settings

Separately set for each zone by selecting the option from the drop-down menu to enable or disable HDCP sink to determine whether the HDMI display(s) responds to HDCP content protection properly and decrypt incoming HDCP data and produce full fidelity digital streams. By selecting **Enable**, the source device connected to the Video Wall Processor and the sink device will do an HDCP handshake to adapt the highest HDCP version supported by the sink device.

Scaler Resolution

Enter the **Scaler Resolution** page to set the resolution for each zone.

The screenshot displays the ATEN Web UI for a 36 x 20 Modular Video Wall Processor (VW3620-ATEN device). The page is titled "Scaler Resolution" and features a navigation bar with "General", "Port Settings", "Status", and "Maintenance" tabs. The main content area is divided into four sections, one for each zone (A, B, C, and D). Each section includes a dropdown menu for "Output" and a "Save" button. The current settings are as follows:

| Zone | Output |
|--------|----------------|
| Zone A | 1920x1080@60Hz |
| Zone B | 1920x1080@60Hz |
| Zone C | 3840x2160@30Hz |
| Zone D | 1920x1080@60Hz |



At the bottom of the page, there are two buttons: "Cancel" and "Save". The "Save" button is highlighted in green, indicating it is the active or default action.

Select the resolution option from the drop-down menu. You can also select **Customized** to set custom resolution for the zone display(s).

By making any changes on this page, the **Save** button located at the bottom of the page becomes available. Click on it to adopt the changed settings.

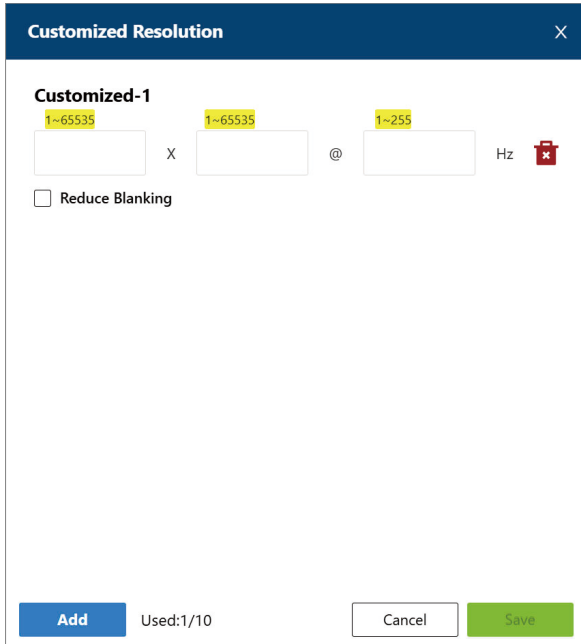
By selecting **Customized**, a popup **Customized Resolution** shows up for the user to configure the resolution.



| Item | Description |
|---|---|
|  | Click to add a user-defined resolution. You can create up to 10 custom resolution settings. |
|  | Click to delete the user-defined resolution. |
| <input checked="" type="checkbox"/> Reduce Blanking | Check the checkbox to enable the function Reduce Blanking to reduce the horizontal and vertical blanking periods on the display(s). |
| <input type="text" value="Cancel"/> | Click to close the popup window and discard the changes you just made. |
|  | Click to save the changes you just made. |

Click on the **Add** button to create a user-defined resolution, and once you finish the configuration, click on the **Save** button to complete the settings.

Now the custom resolution is listed on the drop-down menu:

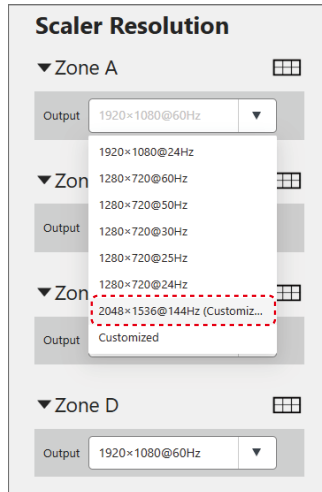

Port Name

Enter the name for the port you'd like to define, and click on the **Apply** button to save your changes.

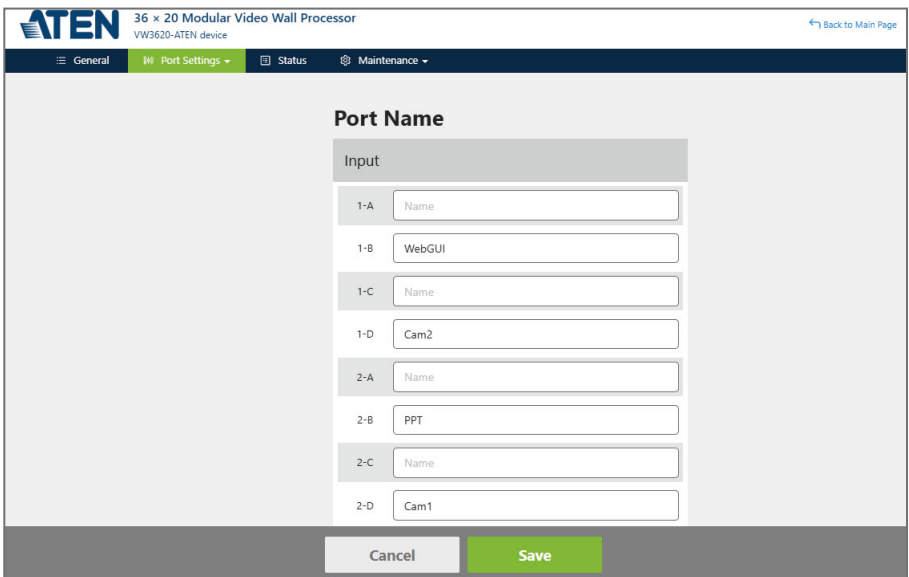

By making any changes on this page, the **Save** button located at the bottom of the page becomes available. Click on it to adopt the changes.

EDID

Extended Display Identification Data (EDID) is a data format that contains a display's basic information and is used to communicate with the video source/system. The **EDID** page lets users view and select an EDID mode so that the Video Wall Processor can use the best resolution for its displays.

The screenshot shows the ATEN Web Management Interface for a 36 x 20 Modular Video Wall Processor (VM3620-ATEN device). The top navigation bar includes 'General', 'Port Settings', 'Status', and 'Maintenance'. The main content area is titled 'EDID' and is divided into two columns: 'EDID Mode' and 'EDID & CEA Description'. In the 'EDID Mode' column, three radio buttons are visible: 'ATEN Default' (selected), 'Port1 Mode', and 'Customized'. Below these is an 'Apply' button and a 'Port EDID Status' section showing 'ATEN EDID 1' as the active mode. The 'EDID & CEA Description' column lists 10 items under the 'EDID' section and 10 items under the 'CEA' section.

| EDID Mode | EDID & CEA Description |
|---|--|
| <input checked="" type="radio"/> ATEN Default | EDID |
| <input type="radio"/> Port1 Mode | 1. Vendor/Product Identification |
| <input type="radio"/> Customized | 2. EDID Structure/Revision |
| <input type="text" value="Apply"/> | 3. Basic Display/Feature |
| Port EDID Status | 4. Color Characteristics |
| ATEN EDID 1 | 5. Established Timings |
| | 6. Standard Timings |
| | 7. Detail Timing/Display Description 1 |
| | 8. Detail Timing/Display Description 2 |
| | 9. Monitor Description |
| | 10. Monitor Description |
| | CEA |
| | 1. Display Support |
| | 2. Video Data |
| | 3. Audio Data |
| | 4. Speaker Allocation |
| | 5. Vendor Specific Data |
| | 6. HDMI Forum Vendor Specific Block |
| | 7. YCBCR 4:2:0 Video Data Block |
| | 8. YCBCR 4:2:0 Capability Map Data Block |
| | 9. Detail Timing/Display Description 1 |
| | 10. Detail Timing/Display Description 2 |

Note: The EDID mode can also be selected via the front panel pushbuttons—see *EDID Mode*, page 53.

EDID Mode

In the left panel of the page, users can select a pre-configured EDID Mode using the EDID Mode radio buttons.

EDID

EDID Mode

ATEN Default
 Port1 Mode
 Customized

Port EDID Status

ATEN_EDID_1

EDID & CEA Description

EDID

1. Vendor/Product Identification
2. EDID Structure/Revision
3. Basic Display/Feature
4. Color Characteristics
5. Established Timings
6. Standard Timings
7. Detail Timing/Display Description 1
8. Detail Timing/Display Description 2
9. Monitor Description
10. Monitor Description

CEA

1. Display Support
2. Video Data
3. Audio Data
4. Speaker Allocation
5. Vendor Specific Data
6. HDMI Forum Vendor Specific Block
7. YCBCR 4:2:0 Video Data Block

| Item | Description |
|--------------|---|
| ATEN Default | All ports' EDID is the same as the hardware default EDID. |
| Port 1 Mode | All ports' EDID is the same as Port1's EDID. |
| Customized | Select the Customized mode to defined the EDID and CEA settings by users. |
| Apply | Click to apply the mode you just selected. |

EDID & CEA Description

The middle panel of the screen lets users view and configure the EDID or the CEA mode.

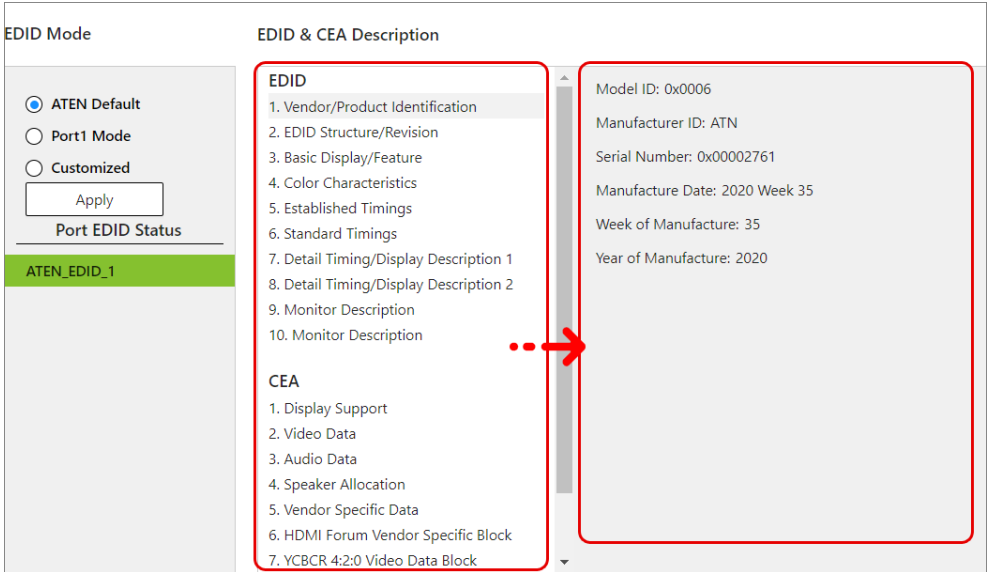

From the middle column, click the option that you want to view and/or edit. There are two categories: **EDID** (Extended Display Identification Data) and **CEA** (Consumer Electronics Association).

When you select the menu items on the middle column, the current settings for the selected EDID appear on the right column. Some of the screens are read-only.

CEC

Consumer Electronics Control (CEC) allows interconnected HDMI devices to communicate and respond to one remote control.

The screenshot displays the ATEN web interface for a 36 x 20 Modular Video Wall Processor (model VW3620-ATEN device). The interface includes a navigation bar with tabs for General, Port Settings (selected), Status, and Maintenance. A 'Back to Main Page' link is visible in the top right corner. The main content area is titled 'CEC' and contains four sections, one for each zone (A, B, C, and D). Each zone section includes a dropdown menu labeled 'Output' with the value 'Disable' selected. At the bottom of the interface, there are two buttons: 'Cancel' and 'Save' (highlighted in green).

Use the drop-down menu to enable/disable CEC for the output ports of the zone. By making any changes on this page, the **Save** button located at the bottom of the page becomes available. Click on it to adopt the changed settings.

HDR

High dynamic range (HDR) displays video content with more luminance, more color and contrast.

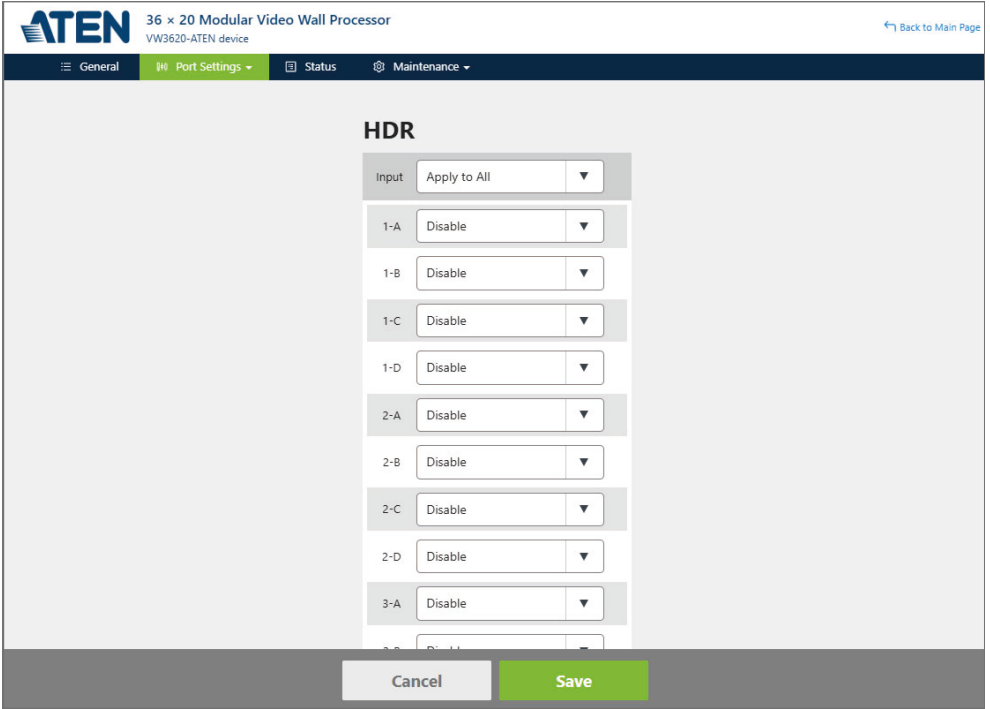

Use the drop-down menu to apply options to all input ports, or set for each input port by selecting **Enable** or **Disable** from the drop-down menu. By making any changes on this page, the **Save** button located at the bottom of the page becomes available. Click on it to adopt the changed settings.

Status

Status page gives you a graphical information about the current working status of the Video Wall Processor.

Click on the component to be checked to open the popup for detailed information.

Output Board 1 ✕

Working Status: Normal

| Model Name | I/O Type | FW Version | Temperature | Power |
|------------|----------|------------|-------------|-----------|
| VW884 | HDMI | V1.1.105 | 40°C | MAX .53 W |

| Port A | Port B | Port C | Port D |
|--------------|--------------|--------------|--------------|
| Connected | Connected | Connected | Connected |
| 1-A:Untitled | 1-B:Untitled | 1-C:Untitled | 1-D:Untitled |

Click on the fan module to open the popup to configure the fan speed between **Auto**, **High**, and **Low**.

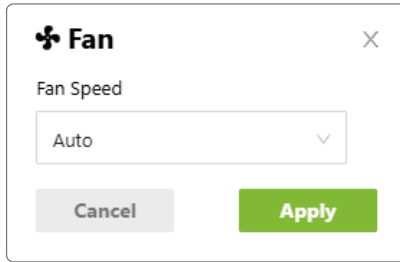

4K60 Mode Configuration

ATEN VW784 input card supports 4K@60Hz input sources. By enabling the 4K60 mode, you are able to play the video at 4K resolution (3840 × 2160) and 60 fps (frames per second) from port A and port C of the selected input card.

Pay attention to your video wall layout arrangement when 4K60 mode is enable:

- ◆ The VW784 input card supports up to four 4K@30Hz inputs or two 4K@60Hz inputs.
- ◆ Each VW884 output port supports up to four windows. When displaying 4K@30Hz sources, all four windows can be used. When displaying 4K@60Hz sources, each video consumes two windows, allowing up to two 4K@60Hz sources per port.

Enable 4K60 Mode

To enable 4K60 mode:

1. Click to open the popup window of the input card to be enabled with 4K60 function.

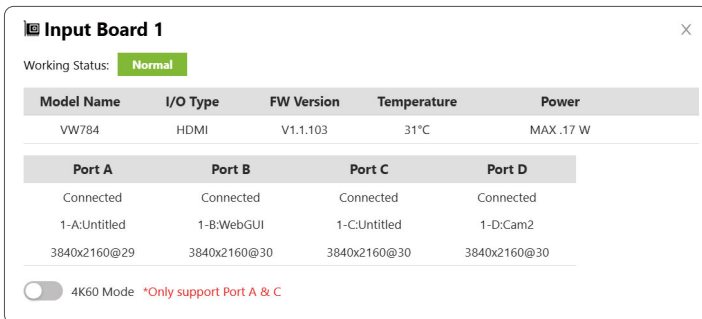

2. Switch to enable the 4K60 mode.

Input Board 1 ✕

Working Status: Normal

| Model Name | I/O Type | FW Version | Temperature | Power |
|------------|----------|------------|-------------|----------|
| VW784 | HDMI | V1.1.103 | 31°C | MAX.17 W |

| Port A | Port B | Port C | Port D |
|--------------|--------------|--------------|--------------|
| Connected | Connected | Connected | Connected |
| 1-A:Untitled | 1-B:WebGUI | 1-C:Untitled | 1-D:Cam2 |
| 3840x2160@29 | 3840x2160@30 | 3840x2160@30 | 3840x2160@30 |

4K60 Mode *Only support Port A & C

Once **4K60 Mode** is enabled, port B and port D become unavailable and go blank.

Input Board 1 ✕

Working Status: Normal

| Model Name | I/O Type | FW Version | Temperature | Power |
|------------|----------|------------|-------------|----------|
| VW784 | HDMI | V1.1.103 | 31°C | MAX.17 W |

| Port A | Port B | Port C | Port D |
|--------------|--------------|--------------|--------------|
| Connected | Connected | Connected | Connected |
| 1-A:Untitled | 1-B:WebGUI | 1-C:Untitled | 1-D:Cam2 |
| 3840x2160@29 | 3840x2160@30 | 3840x2160@30 | 3840x2160@30 |

4K60 Mode *Only support Port A & C

36 × 20 Modular Video Wall Processor
VW3620-ATEN device

Preview

Design Mode

🔌 🗑️ 🔄 🖨️

A-LED ↕
Output ID
Input ID
Window ID

Source(10)

4K60 ID

4K60 ID

4K60 ID

4K60 ID

4K60 ID

Create new window

1-A:Untitled

1-C:Untitled

2-A:Untitled

2-B:PP1

2-C:Untitled

Property

Profile

Save to Prof. 🟢

Preview

P1:Default-创景-创景设置
 P2:OSM PP1X3
 P3:OSM PP1X3 字幕
 P4:OSM PP1X2

Auto Apply

Apply

Cancel

The 4K60 video source is highlighted with a red badge:

- ◆ On **Design Mode** screen:



- ◆ On **Video Source List**:



- ◆ On **Source Array** screen:

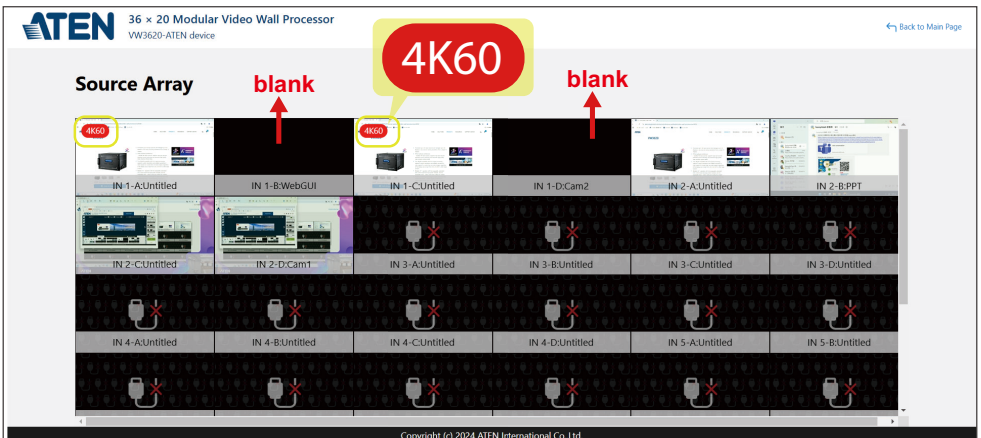

Maintenance

Move the cursor over the menu item **Maintenance** to expand the submenu, and click on the submenu option you'd like to configure to enter the page.

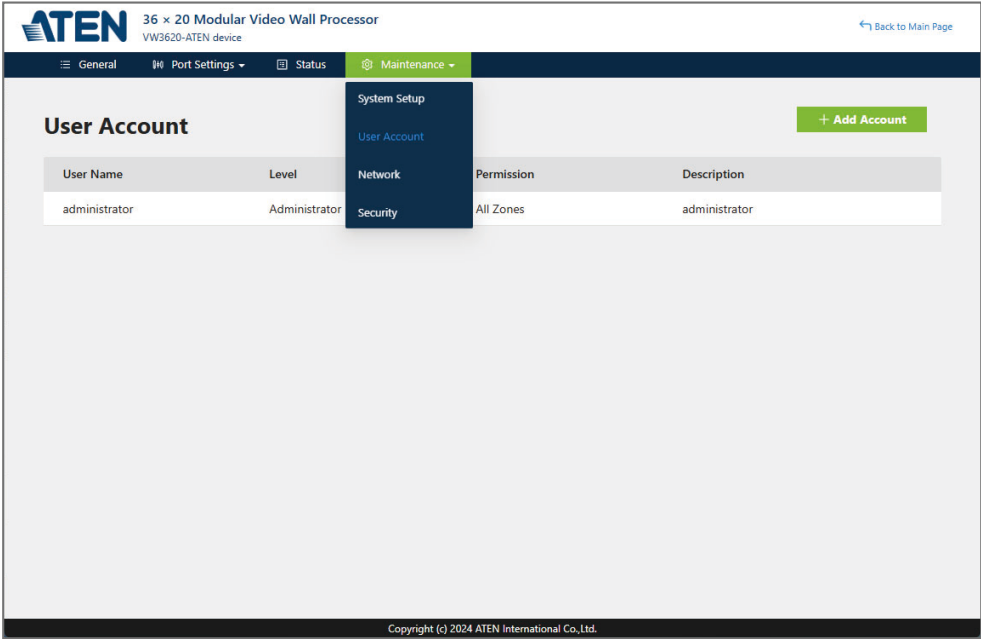

System Setup

You can use the **System Setup** page to do any of the following:

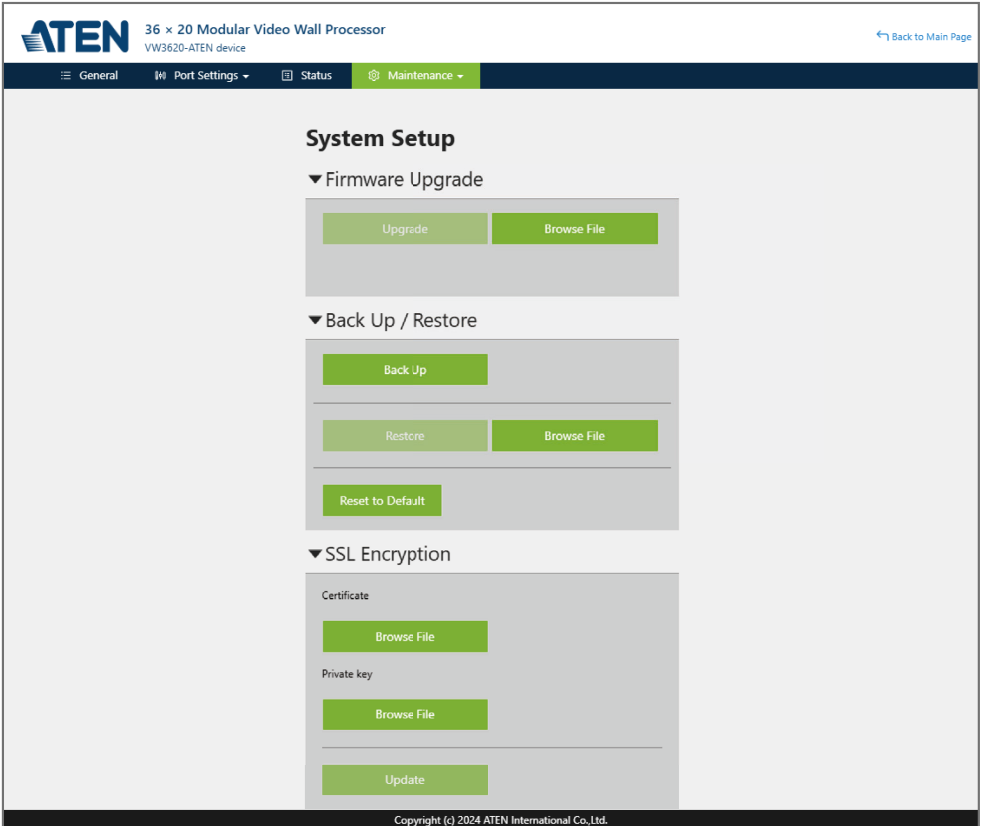

- ◆ Upgrade the Video Wall Processor’s firmware.
- ◆ Back up or restore the Video Wall Processor’s settings. Note that account settings cannot be backed up or restored.
- ◆ Configure the **SSL Encryption** settings.

User Account

The **User Account** page lets you check, add, edit, or delete users and change the password for accessing the Video Wall Processor's Web GUI.

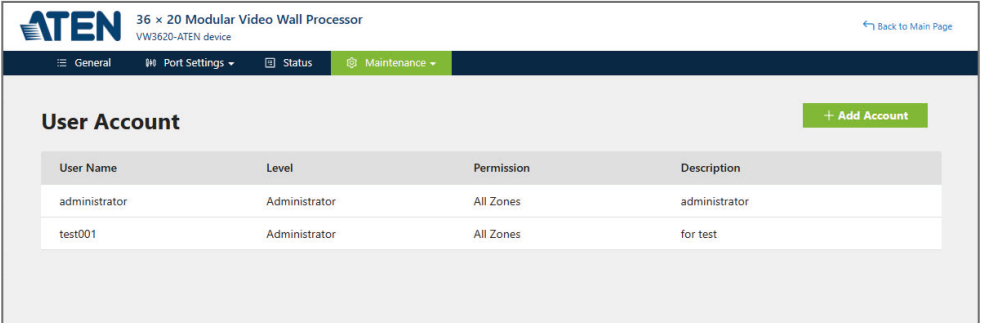

36 x 20 Modular Video Wall Processor
VW3620-ATEN device

← Back to Main Page

General Port Settings Status Maintenance

User Account + Add Account

| User Name | Level | Permission | Description |
|---------------|---------------|------------|---------------|
| administrator | Administrator | All Zones | administrator |
| test001 | Administrator | All Zones | for test |

Note: This is an **Administrator** only function.

Add a New User

To create a new user account, do the following:

1. Click the **Add Account** button to open the **Add / Edit Account** popup.

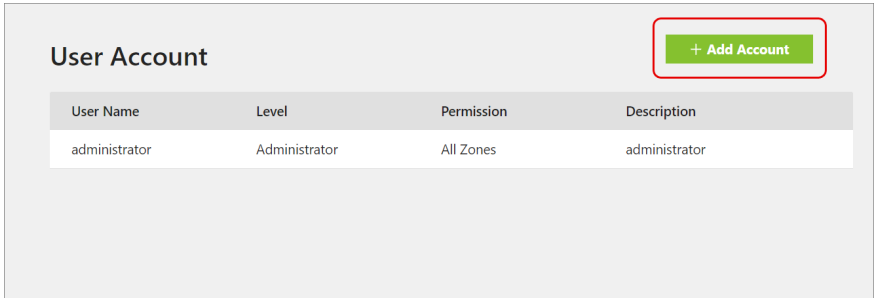

User Account + Add Account

| User Name | Level | Permission | Description |
|---------------|---------------|------------|---------------|
| administrator | Administrator | All Zones | administrator |

2. Fill in the required field.

Add / Edit Account
✕

User Name

Description:

Password

Confirm Password

Please enter 5-16 characters without these special characters <>[]()*+=?@/\'!,:;" space &

Level

Administrator: Preview / Design / Calendar / Settings

Advanced User: Preview / Design / Calendar

Basic User: Preview / View Calendar

Permission

zone A zone B zone C zone D

Delete

Cancel

Save

| Item | Description |
|------------------|---|
| User Name | The account used to log in to the Web GUI |
| Description | Any description you'd like to add to this user |
| Password | The password for this user to log in to the Web GUI |
| Confirm Password | Enter the password again for confirmation. |
| Level | Assign the user role type for this user: <ul style="list-style-type: none"> ◆ Administrator ◆ Advanced User ◆ Basic User |
| Permission | Check the check box(es) to select the zone(s) this |
| Cancel | Close the popup and discard the settings. |
| Save | Click on the save button to create this user account. |

3. Click on the **Save** button to complete.

Edit / Delete an Existing User

On the user list, pass your cursor to the user to be edited, and an **Edit** option appears. Click on it to open the **Add / Edit Account** popup. To edit the user account, make changes and then click on the **Save** button. To delete the user account, directly click on the **Delete** button to remove this user.

| User Account | | | | + Add Account |
|---------------|---------------|------------|---------------|-------------------------------|
| User Name | Level | Permission | Description | |
| administrator | Administrator | All Zones | administrator | |
| test123 | Basic User | All Zones | | Edit |

Network

The **Network** page lets you configure the Video Wall Processor’s IP settings for connecting to it via the web GUI.

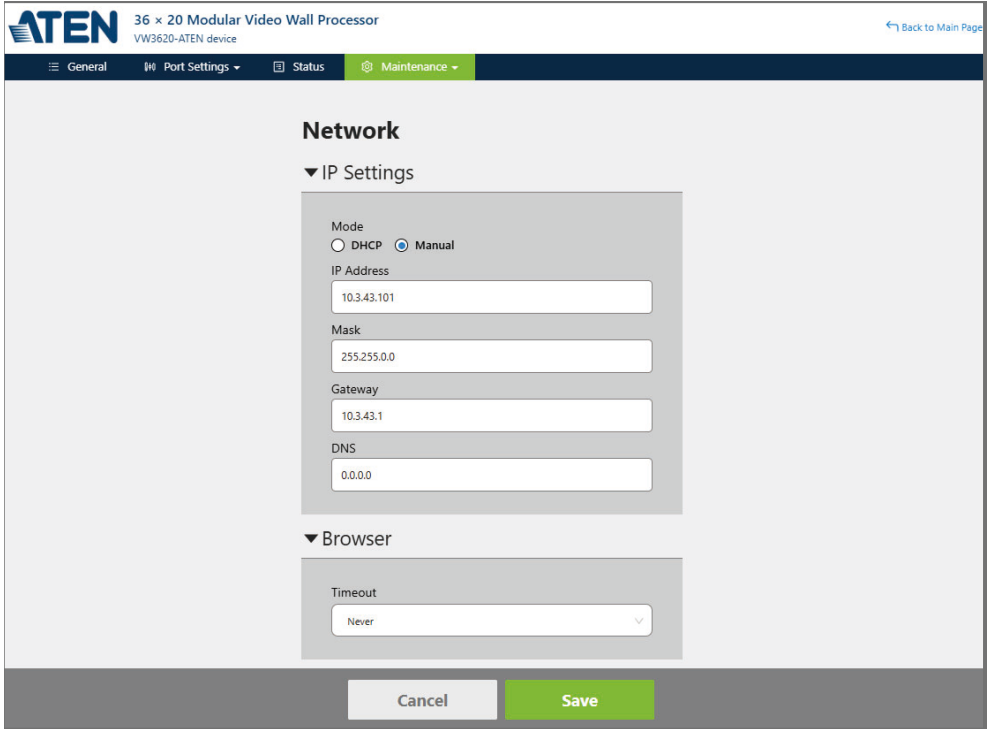

| Item | Description |
|--------------------|--|
| IP Settings | |
| Mode | Enable DHCP to allow the DHCP server to assign an IP address to the Video Wall Processor. Select Manual to enter your own static IP address settings for the device. |
| IP Address | Set the IP address for this Video Wall Processor. |
| Mask | Configure the mask settings for this Video Wall Processor. |
| Gateway | Configure the gateway settings for this Video Wall Processor. |
| DNS | Configure the DNS settings for this Video Wall Processor. |

| Item | Description |
|----------------------|---|
| Browser | |
| Timeout | Set the inactive duration before the system automatically log the user out. |
| IP Installer | |
| Mode | <p>Configure the mode that your Video Wall Processor to work with the ATEN's program, IP Installer, if you have installed it on your computer.</p> <ul style="list-style-type: none"> ◆ Enable The unit's IP address can be found by IP Installer and configured through the Set IP function of IP Installer. ◆ View Only The unit's IP address can be found by IP Installer, but it cannot configured through IP Installer. ◆ Disable The unit's IP address cannot be found by IP Installer. |
| Save / Cancel | By making any changes on this page, the Save button located at the bottom of the page becomes available. Click on it to adopt the changed settings. Click on Cancel to discard the changes. |

Security

Security page allows the user to set the following:

The screenshot shows the ATEN 36 x 20 Modular Video Wall Processor Security configuration page. The page title is "Security" and it includes a navigation bar with "General", "Port Settings", "Status", and "Maintenance" tabs. The "Maintenance" tab is active. The page content is organized into three sections:

- Account Lockout Policy:**
 - Account Lockout:
 - Maximum Invalid Login Attempts (1-999):
 - Account Lockout Duration (1-999 mins):
- Connection:**
 - Telnet Login:
- Transport Layer Security:**
 - Transport Layer Security:

At the bottom of the page, there are "Cancel" and "Save" buttons. The footer text reads "Copyright (c) 2024 ATEN International Co., Ltd."

| Item | Description |
|--|---|
| Account Lockout Policy | |
| Account Lockout | To enable or disable the function that locks the login account after a certain number of failed sign-in attempts. |
| Maximum Invalid Login Attempts (1-999) | Enter the maximum number of failed sign-in attempts. |

| Item | Description |
|--|--|
| Account Lockout Duration (1—999 mins) | Define the number of minutes that a locked-out account remains locked out before it gets unlocked. |
| Connection | |
| Telnet Login | To enable or disable the Telnet login function. |
| Transport Layer Security | |
| Transport Layer Security | Select the TLS version to be adopted. |

Once you finish your configuration about the security, click the **Save** button to make the change to take effect.

This Page Intentionally Left Blank

Chapter 5

Tablet Control

Overview

The Video Wall Processor supports remote control via Android tablets and iPads by accessing its built-in Graphical User Interface (GUI) through a browser app. The operation on a tablet is nearly identical to the PC version of the Video Wall Processor Web GUI. In this chapter, we will highlight the operational differences compared to the PC version. Refer to the following sections for instructions on how to control and configure your Video Wall Processor using a mobile device.

Note: All screenshots and illustrations in this chapter use an Android tablet controlling the VW3620 as an example. Tablet-based Web GUI operation is identical on the VW1608 and applies to both Android tablets and iPads.

Logging In

To access the Video Wall Processor Web GUI via a mobile device:

1. Launch a browser app and enter the IP address of your Video Wall Processor. The login page shows up:

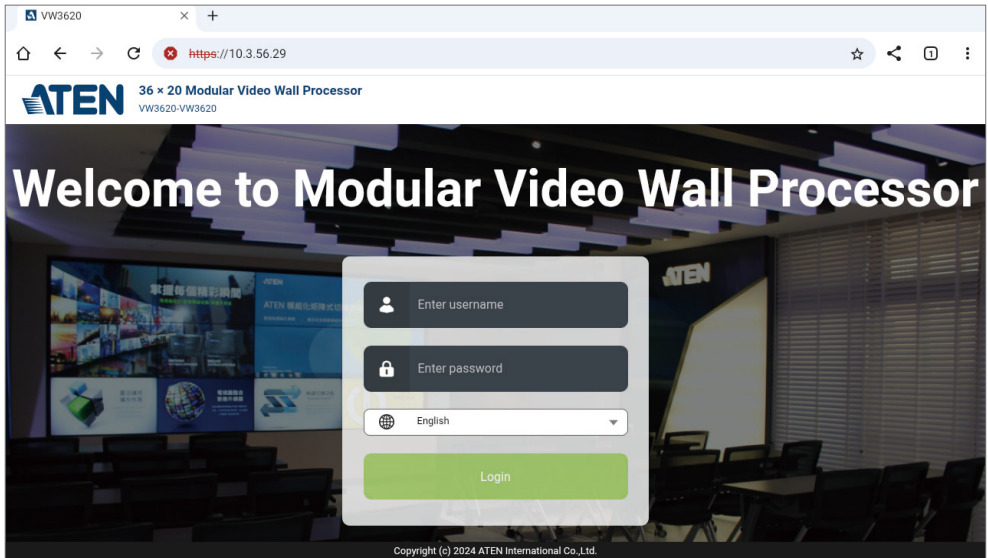

2. Select the display language and enter your username and password to log in.
3. After successfully logging in, you will enter Video Wall Processor Web GUI **Design Mode** page. The design mode of tablet version is slightly different from the PC version as the figure below shows:

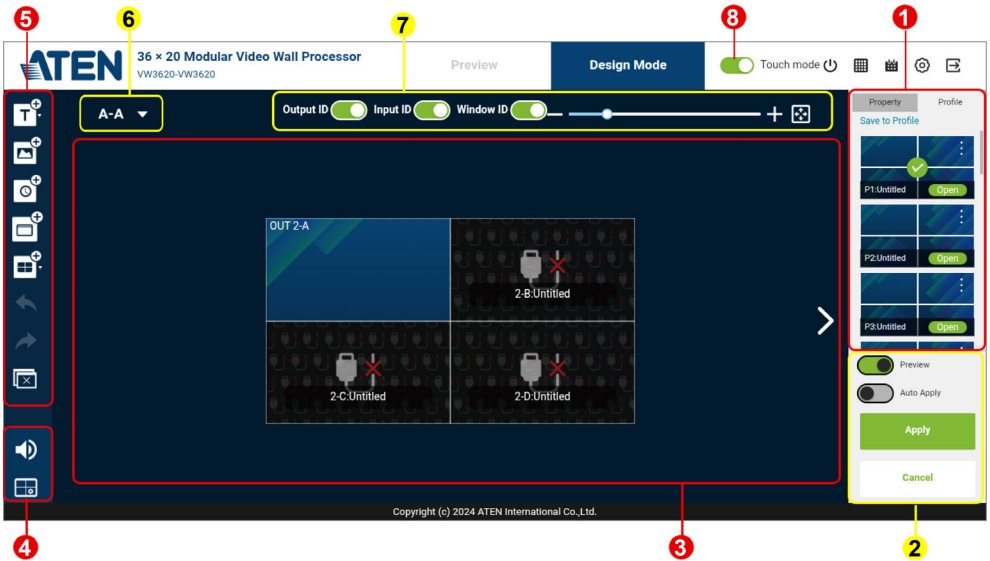



| No. | Item | Description |
|-----|---------------------------|--|
| 1 | profile panel | <p>The profile panel consists of the two tabs:</p> <ul style="list-style-type: none"> ◆ Profile List: Displays all available profiles, including unedited ones. ◆ Property Settings: Shows the properties of selected items within a profile. Users can edit these properties or use the show/hide button to reveal or conceal selected items. |
| 2 | profile playing functions | <p>Profile playing functions allow users to control how a profile is applied to the video wall:</p> <ul style="list-style-type: none"> ◆ Preview: Displays the live source video for a quick view. ◆ Auto Apply: Automatically applies the profile when opened. ◆ Apply: Manually apply the profile to the video wall. ◆ Cancel: Discards any unsaved changes. |

| No. | Item | Description |
|-----|---------------------------------------|--|
| 3 | canvas area | Canvas area is where you design and arrange the display zones. Use the side buttons (prev / next) to switch between zones. |
| 4 | audio & display configuration buttons | Use these buttons to adjust audio output and display layouts: <ul style="list-style-type: none"> ◆ Audio Control: Configure output audio settings per port or apply settings to all. ◆ Display Configuration: Arrange display layouts for each zone. |
| 5 | canvas toolbar | The canvas toolbar provides 8 tools for editing the display layout, including options to add text, images, clocks, and video windows, as well as undo, redo, and clear actions. |
| 6 | zone navigation drop-down menu | Tap to open zone options and switch to your desired zone. |
| 7 | layout configuration tools | Layout configuration tools help adjust layout visibility and item order within the display zone. Functions include toggling port IDs, rearranging item layers (bring forward/back), removing items, and zoom controls for resizing the canvas view. |
| 8 | touch mode switch | When accessing the Web GUI from a tablet browser, Touch Mode is enabled by default. In this mode, the interface is optimized for touch interaction and supports drag-and-drop profile control. When Touch Mode is disabled, the interface switches to the PC-style layout, displaying the source list, but drag-and-drop is not available. Profiles and other functions can still be operated by tapping. |

See *Interactive Functions on Design Mode Tab*, page 82 for details.

When operating the Video Wall Processor with a tablet, pay special attention to the use of the following two buttons on the canvas toolbar:

| Item | Description |
|---|---|
|  | <p>Create Window</p> <p>Click the button to open Select Source Popup to further set the video source. See <i>Single Source Operation</i>, page 135 for details.</p> |
|  | <p>Create Multiview Window</p> <p>Click the button to open the option menu to select the window type and open the Multiview Editor popup to edit the input sources. See <i>Multiview Window Configuration</i>, page 138 for details.</p> |

Profile List Operation

This section describes how to manage profiles using the tablet browser interface. The user flow and UI responses may differ slightly from the PC browser version.

Opening a Profile

To open a profile, scroll to find the one you need and tap the **Open** button.



Alternatively, tap the more button to open the options menu, then select **Open** to load the profile.

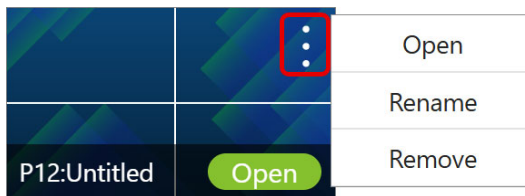

Editing a Profile

To edit an existing profile:

1. Open the profile you'd like to make changes.
2. Tap to select an item and edit it using **Property** and layout configuration tools.

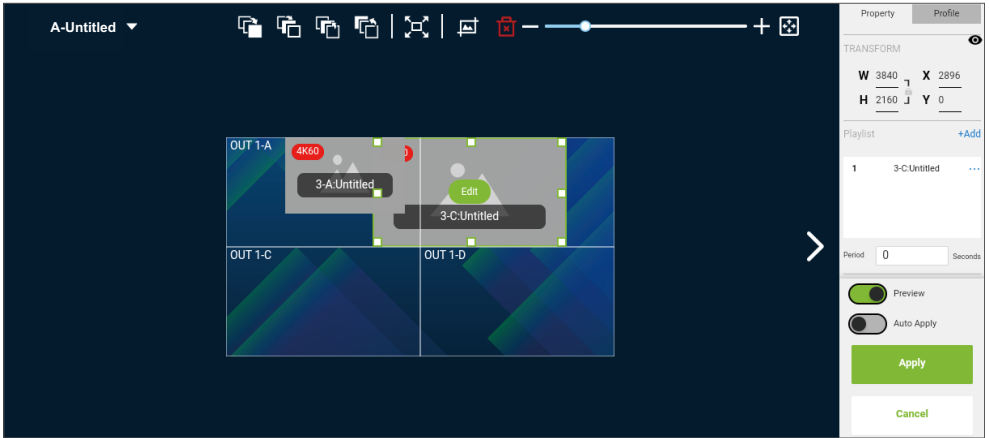

3. Tap to open profile list tab, and tap **Save to Profile** to save your changes.

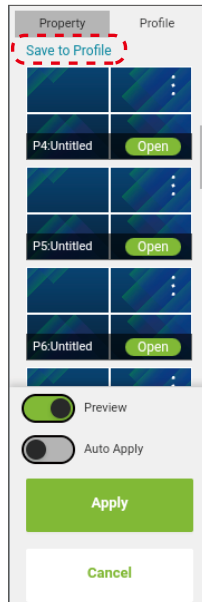

Deleting a Profile

To delete a profile:

1. Tap the more button on the target profile to open the option menu.

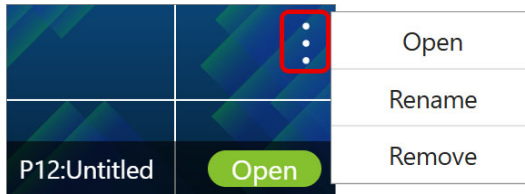

2. Select **Remove** from the menu.
3. In the confirmation dialog, tap **OK** to proceed.

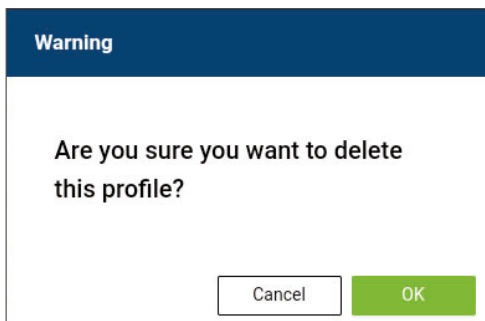

Note: This action cannot be undone. Make sure the selected profile is no longer needed before confirming deletion.

4. The selected profile will be cleared and reset to an empty state.

Single Source Operation

Adding a Window

To add a window that displays a single video source or user-defined video source(s), follow these steps:

1. From the canvas toolbar, tap the **Create Window** button .
2. The **Select Source** popup appears. Tap the **Input** tab to view all input video sources from connected devices, or tap the **Customized** tab to view user-defined video source(s).

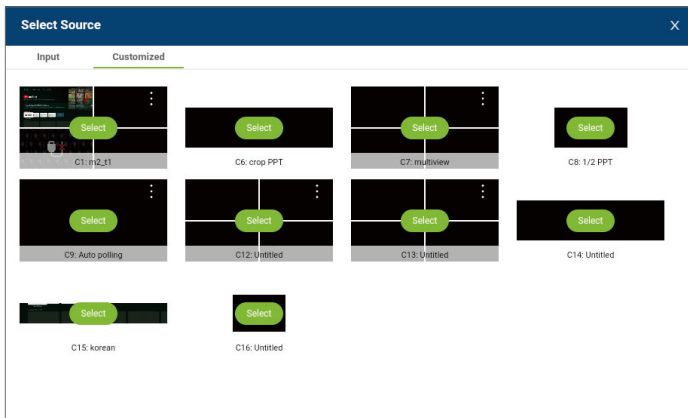

3. Find the desired video source and tap its **Select** button  to apply it.
4. The window will now appear in the display area.

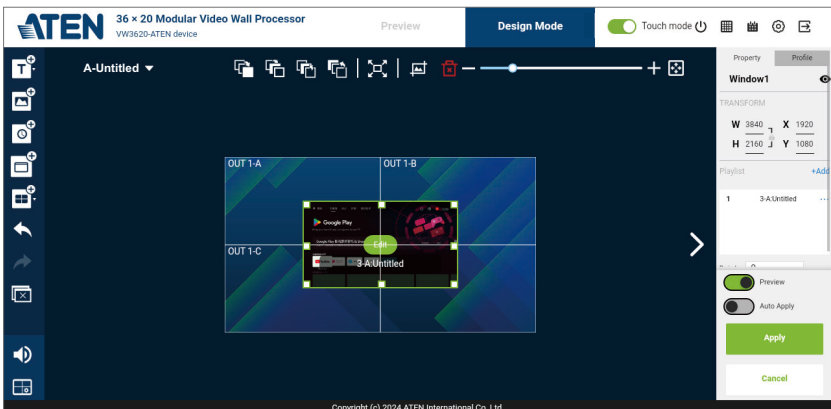

Video Source Management

To change the source:

1. Tap the **Edit** button on the window you want to modify.



2. The **Select Source** popup appears, containing **Input** and **Customized** tabs:

- ◆ **Input Tab:**

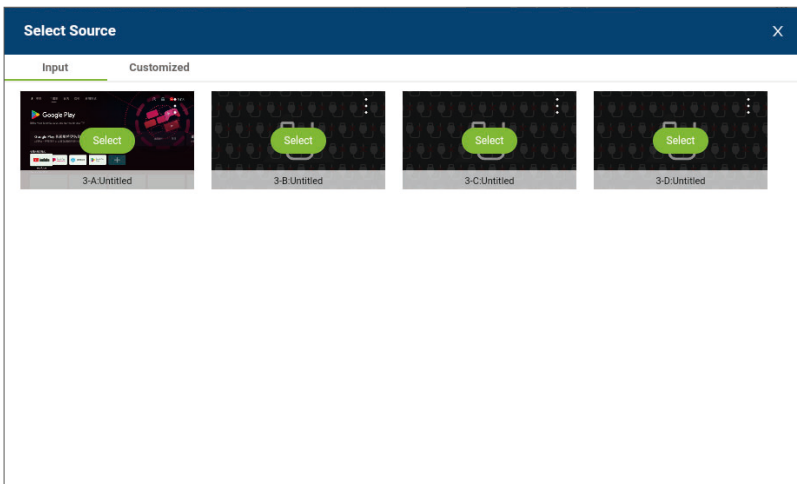

◆ Customized Tab:

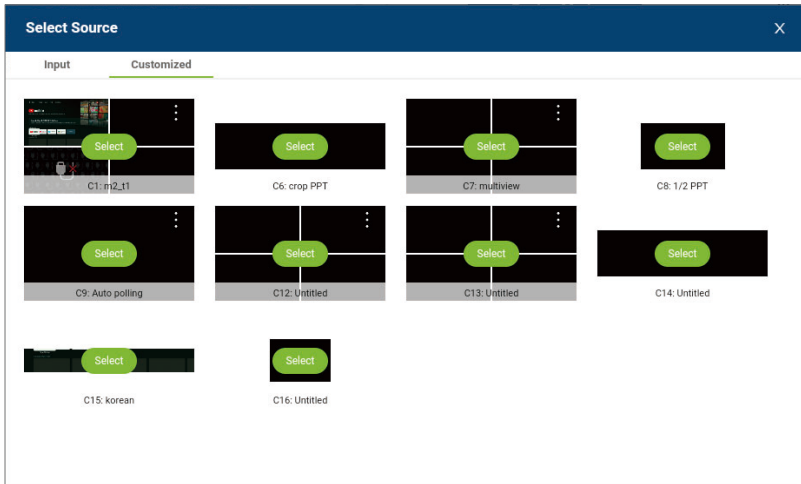

3. Find the desired source and tap the **Select** button to apply it.

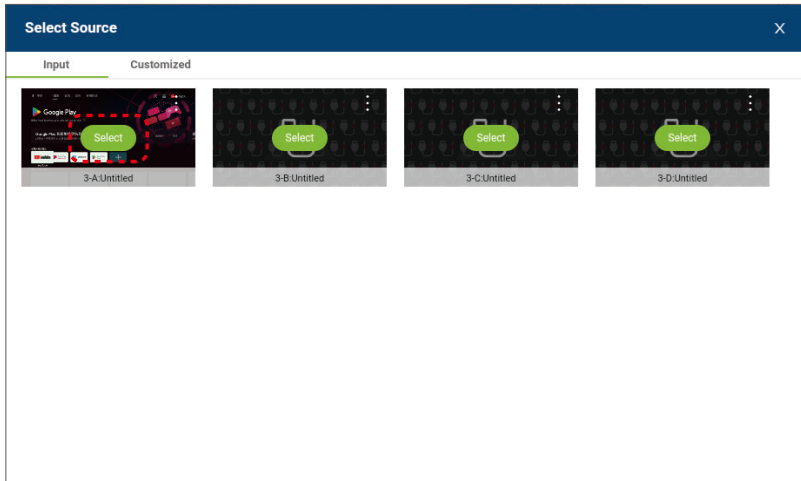

Multiview Window Configuration

The operations in this section is optimized for tablet-based interaction.

Create a Multiview Window

To create a multiview window, follow these steps:

1. Tap the **Create Multiview Window** button  on the canvas toolbar to open the option menu to elect the desired layout type.



2. The **2 x 2** or **4 x 4** **Multiview Editor** popup appears. Tap a sub-window to assign its video source.

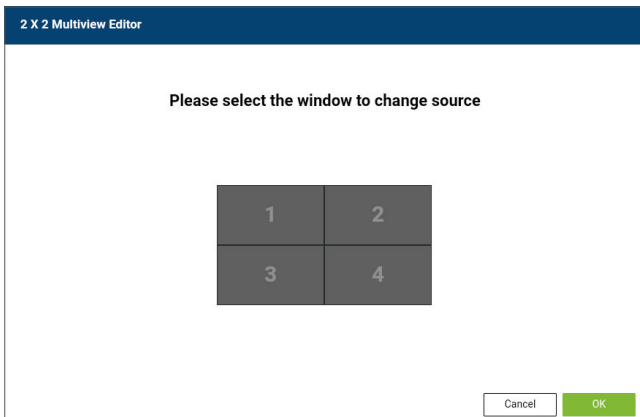

3. On the multiview editor:

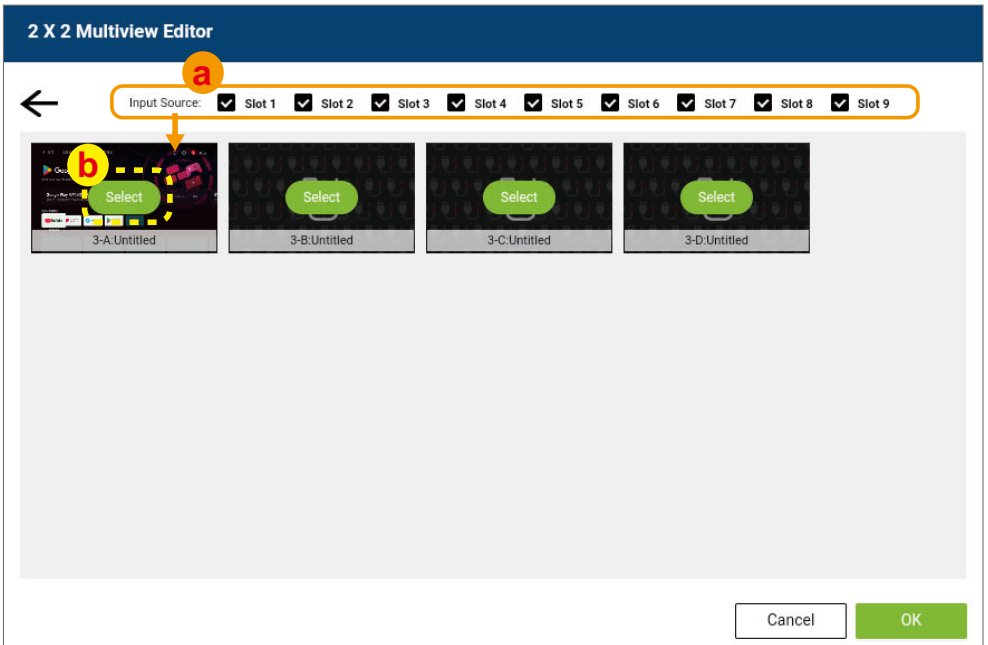

- a) Select the slot(s) to define which input sources are available for this multiview window.
 - b) Tap the **Select** button on the desired source to apply it to the selected sub-window.
4. Repeat as needed to complete the layout. Tap **OK** to confirm.

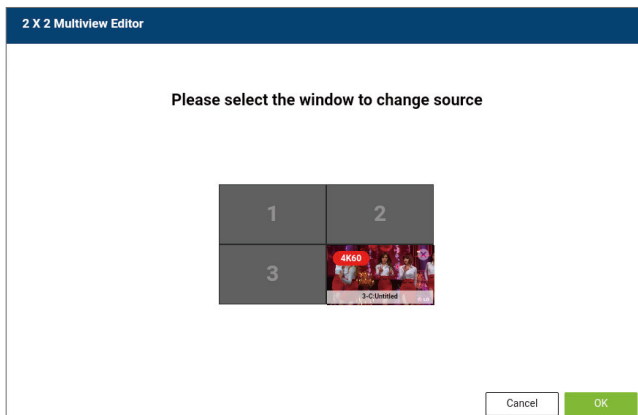

5. The newly created multiview window will now appear on the canvas.



After placing the multiview window on the canvas, you can reposition or resize it by tapping and dragging the frame markers.

Editing / Deleting a Multiview Window

To edit a multiview window:

1. On the canvas, tap to select the target window.
2. Tap the **Edit** button on the window to open the **Multiview Editor** and change its video source.

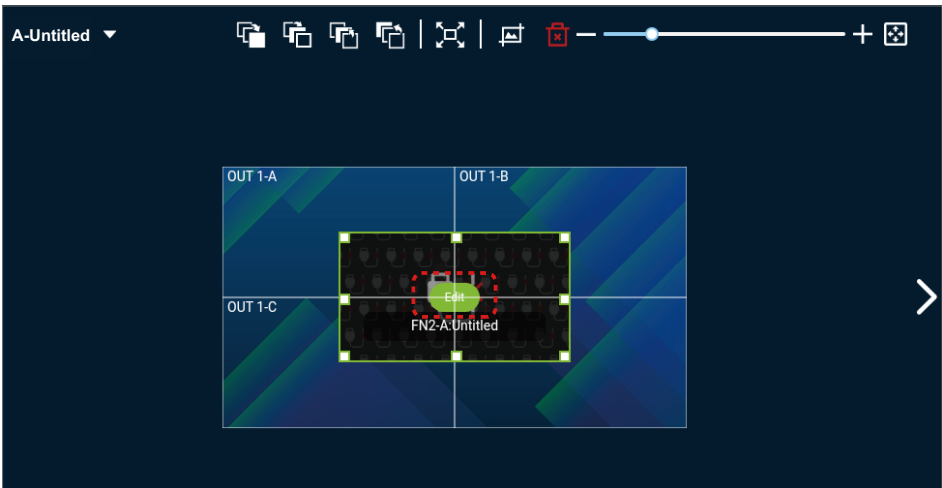

3. Resize the window frame by dragging the adjustment markers.

To delete a multiview window:

1. On the canvas, tap to select the desired window.
2. Tap the **Delete** button in the layout configuration toolbar.

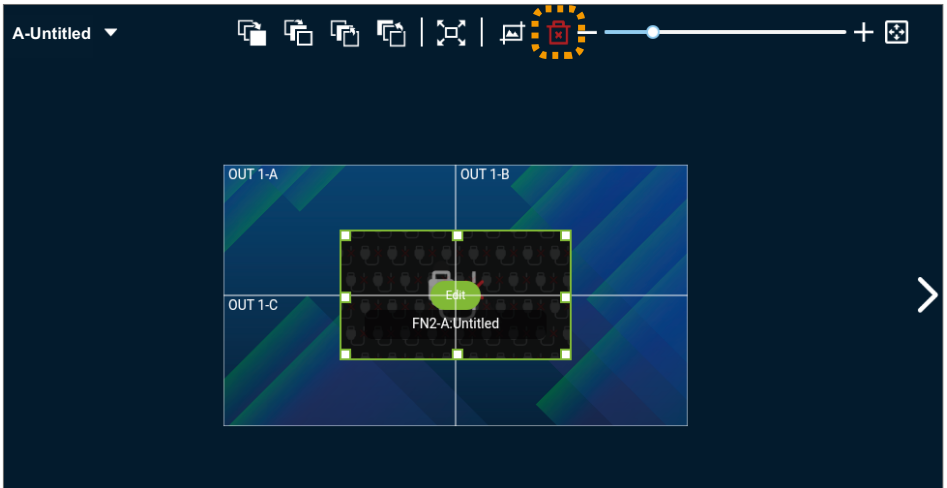

Window Behavior and Adjustment

Adding an Image

To add an image using a tablet:

1. Tap the **Add Image**  button on the canvas toolbar.



2. The **Select an image** window opens. You can:

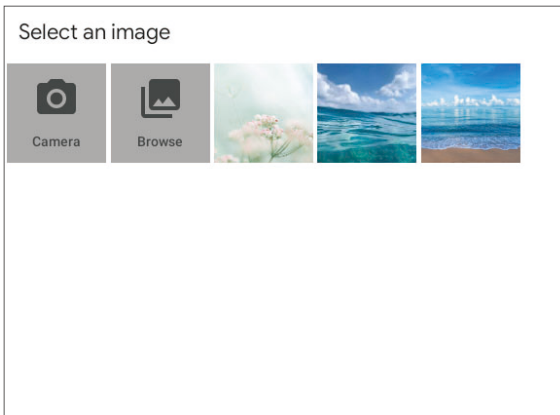

- ◆ Choose an image directly.
- ◆ Select **Camera** to take a photo.
- ◆ Tap **Browse** to find an image from the tablet's internal storage.

- The selected image will appear on the canvas. Resize it if needed.

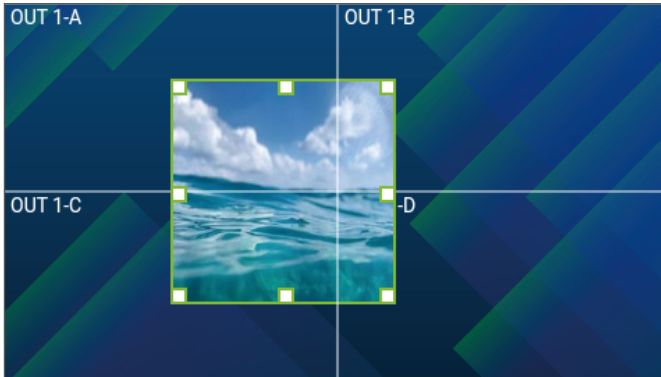

Note: Depending on the tablet OS, the operation steps may vary. The examples shown here are based on an Android tablet; the workflow on iPad may differ slightly.

Layout Management

Resizing

To change the frame of a displayed item:

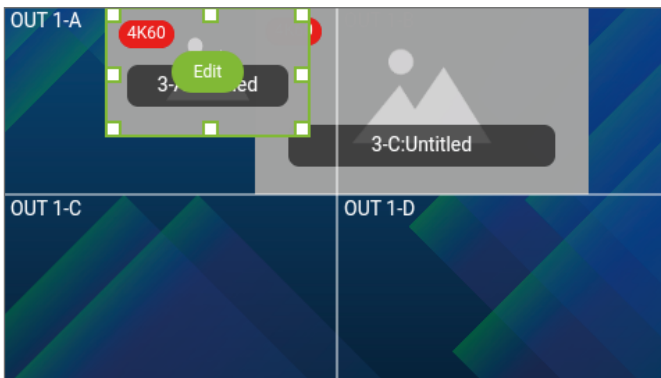

- Tap the window, image, or clock you want to edit.
- A green box with square adjustment markers will appear around the item.
- Drag the markers inward or outward to resize the item.

3. A red box with four square adjustment markers will appear around the item, along with three function buttons:



| Function | Description |
|----------|------------------------------|
| Done | Confirm the changes. |
| Reset | Revert to the previous crop. |
| Cancel | Discard all changes. |

4. Drag the markers inward or outward to crop the item as desired.

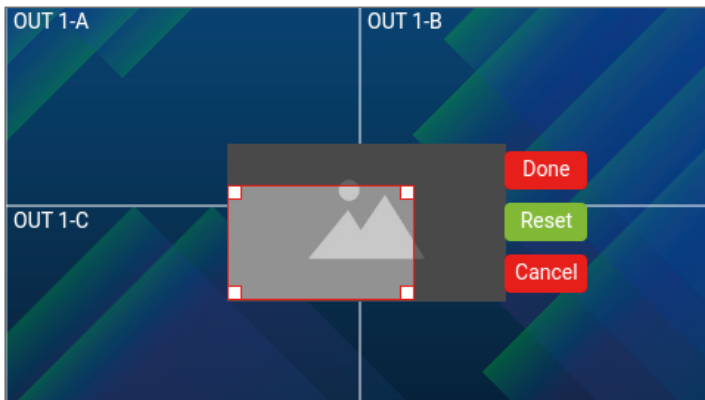

5. Tap the Done button to apply the crop.

This Page Intentionally Left Blank

Chapter 6

Device Chaining

Overview

This section explains how to configure and manage device chaining for the Video Wall Processor, including backup and expansion scenarios. The system supports chaining via Primary and up to two Secondary units. Depending on the mode, chained devices can either provide redundancy (**Backup Mode**) or expanded output capacity (**Expansion Mode**).

| Mode | Purpose |
|----------------|---|
| Backup Mode | Provides redundancy. The Secondary unit remains in sync with the Primary and takes over if the Primary fails. |
| Expansion Mode | Increases output capacity. Multiple units operate simultaneously under centralized control. |

Note: All illustrations in this chapter use the VW3620 as an example. Device chaining operation and behavior are identical on the VW1608.

Hardware Setup

Connection Rule

The connection sequence determines the device roles in the chain mode. The unit connected at the start of the chain functions as the primary device, while the following units become the secondary devices.

- ◆ In all chain modes, only the primary unit can be actively configured through its Web GUI.
- ◆ Secondary units are read-only, allowing monitoring but not editing.
- ◆ All display layout and port configuration changes must be performed on the primary.

Note: The primary and secondary units must reside on the same network domain and have interconnection capability. Without proper network communication, synchronization between the primary and secondary devices will not function.

Backup Mode

To enable **Backup Mode**, simply connect the chain out port of the primary unit to the chain in port of a secondary unit (Secondary 1) using an RJ-45 cable.

VW3620 Rear View (Primary Unit)

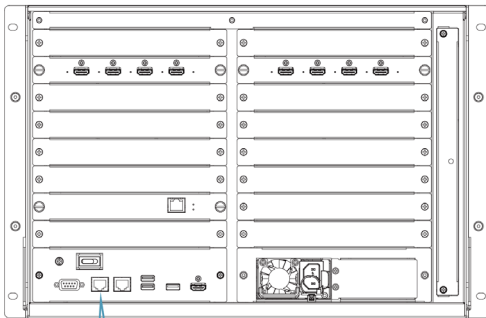

VW3620 Rear View (Secondary 1)

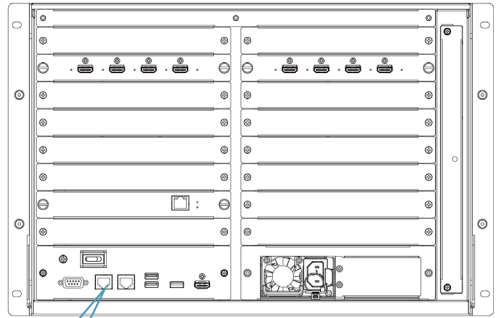

- ◆ Connect the **Chain Out** port of the Primary unit to the **Chain In** port of a Secondary unit (Secondary 1) using an RJ-45 cable.
- ◆ **Backup Mode** supports only one Secondary unit.
- ◆ When enabled, Secondary 1 keeps its configurations synchronized with the Primary in real time. It remains synchronized but does not assume control or output until the Primary disconnects or fails.

Expansion Mode

To enable **Expansion Mode**, install the Video Wall Processor units as follows:

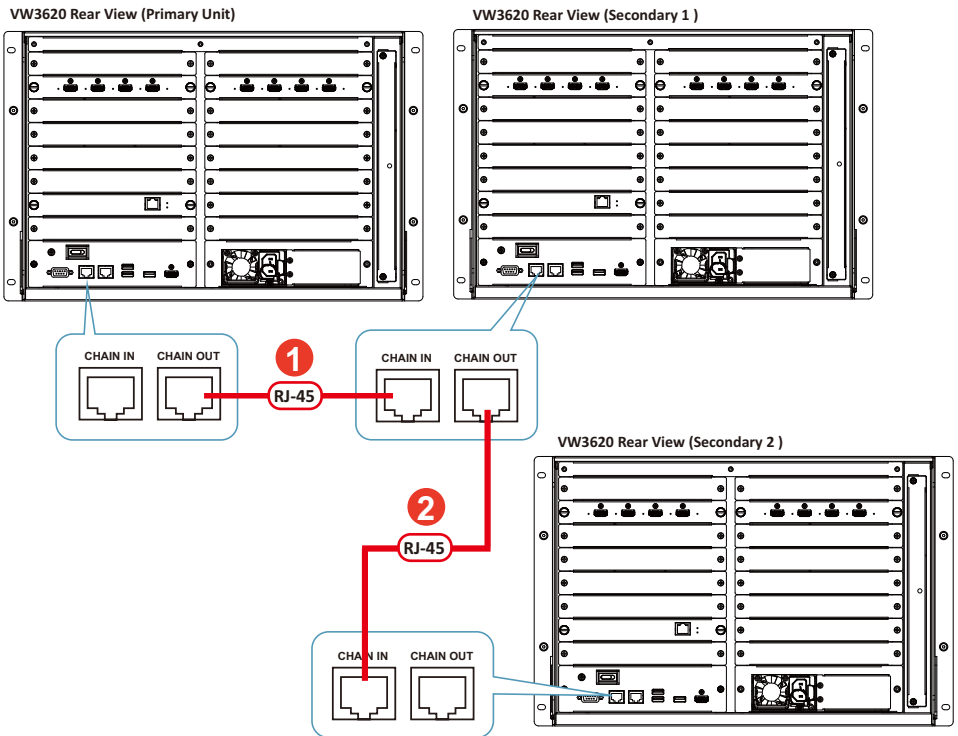

1. Connect the chain out port of the Primary to the chain in port of Secondary 1.
2. (Optional) Connect Secondary 1 to Secondary 2 in the same manner.

Example System Architecture

The figure below is an example system architecture:

Example System Architecture Using VW3620 Units in Expansion Mode

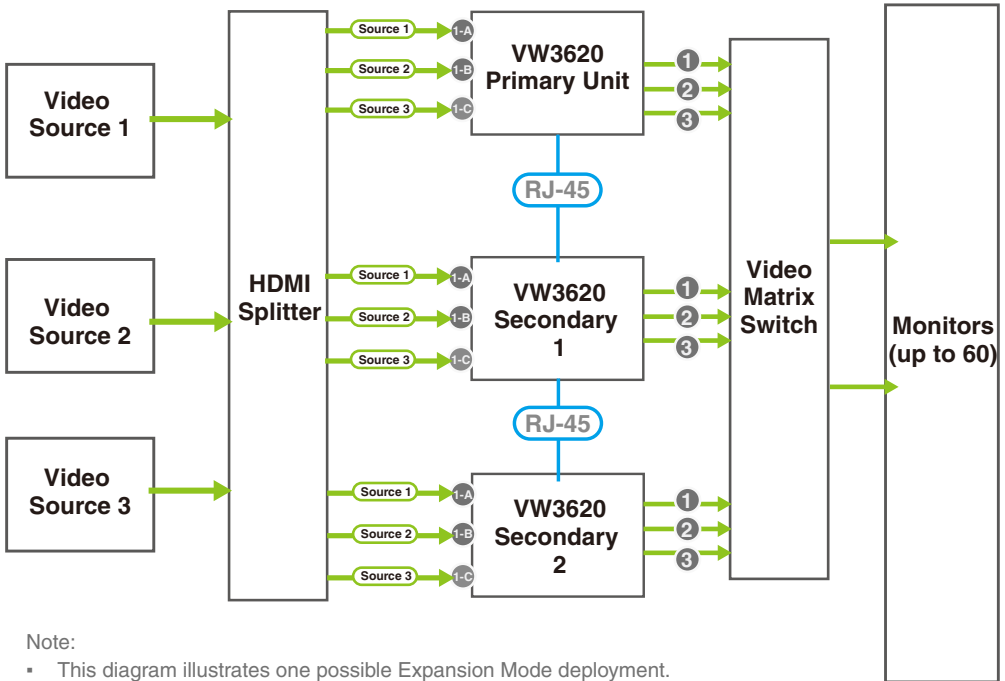

Note:

- This diagram illustrates one possible Expansion Mode deployment. Actual installation may vary based on project requirements.
- RJ-45 connections between units are used for control signaling only, not for video transmission.

The diagram illustrates a typical deployment of VW3620 units in an **Expansion Mode** scenario. An HDMI splitter distributes identical video signals to the primary and all secondary units.

Since the RJ-45 connection between units is used solely for control communication—not for video transmission—each VW3620 unit must receive the video sources in the exact same input order. For example, if Source 1, 2, and 3 are connected to Input 1-A, 1-B, and 1-C on the primary unit, the same source-to-port mapping must be applied to all secondary units.

Browser Operation

Device chain status is displayed in the Web GUI, including each unit's role, IP, and sync state. Log in to your Video Wall Processor web GUI of the primary unit, and go to **Settings > General**. Scroll down to **Device Chain Configuration** for further settings.

Chain Status : Disable Refresh

| Order | Device Information | Status |
|-------------|-------------------------------|--------|
| Primary | Name (192.168.1.250)(Current) | -- |
| Secondary 1 | Name (192.168.1.251) | -- |
| Secondary 2 | -- | -- |

Chain Mode

-- / Backup (only support Primary & Secondary) / Expansion
▼

Enable

Disable

Chain Status

Chain Status defines four possible states along with their corresponding color indicators, helping users quickly identify the current status of all chained devices.

| Status | Indicator | Description |
|---------|--|---|
| Enable | ● Green | Chain is enabled and operating normally; all devices are in Ready status. |
| Disable | ● Gray | Chain mode is off; all devices are in inactive (--) status |
| Syncing | ● Orange | Data synchronization in progress across all chained devices. |
| Error | ● Red | One or more chained devices is in Error or Disconnected status. |

Device status gives the possible device statuses in a chained setup, explaining the operational state of each unit:

| Status | Description |
|------------------|---|
| Working | The device is functioning normally as the primary unit. |
| Syncing | The device is syncing data to the secondary unit(s). |
| -- (Inactive) | No mode is activated; the device is in standby or unconfigured state. |
| Error | The device encountered an issue (e.g., not detected or abnormal operation). |
| Disconnected | The device is offline or not connected. |

Chain Mode

Device chaining allows you to link multiple units to work together under two modes:

- ◆ **Expansion Mode:**
The secondary units extend display output capacity, allowing all units to operate simultaneously.
- ◆ **Backup Mode:**
The secondary device stay in sync with the primary but cannot be operated unless the primary fails.

Note: When three units are connected—Primary, Secondary 1, and Secondary 2—**Backup Mode** is not supported.

Device Chain Configuration

When a chained device is detected, a popup appears in the primary unit's Web GUI, prompting the user to go to the settings page for configuration. Please note that only the primary device can activate chain modes.

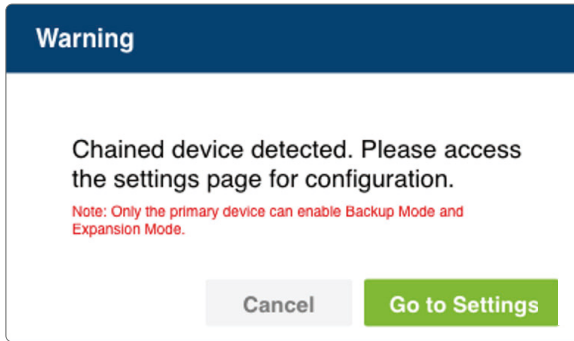

Enabling Chain Mode

To enable chain mode:

1. On the Primary unit's Web GUI, navigate to **Settings > Device Chain Configuration**. Verify that **Chain Status** is set to **Disable**.

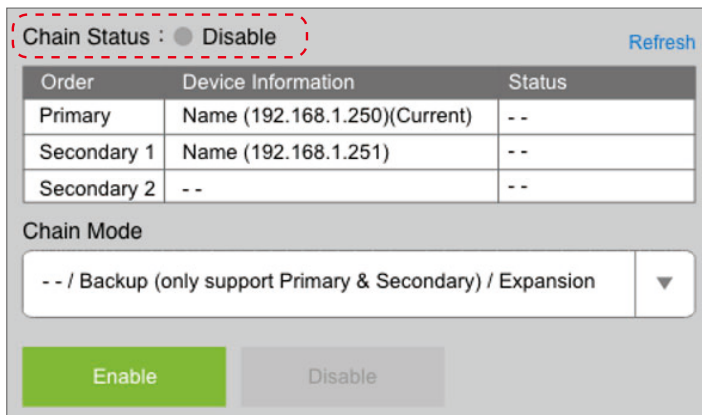

2. From the **Chain Mode** dropdown, select either:
 - ♦ **Backup Mode**—supports only one secondary unit.
 - ♦ **Expansion Mode**—supports multiple secondary units.
 Click the **Enable** button to proceed.

3. A warning popup appears. Click **Apply** to confirm.
 - ◆ Backup Mode

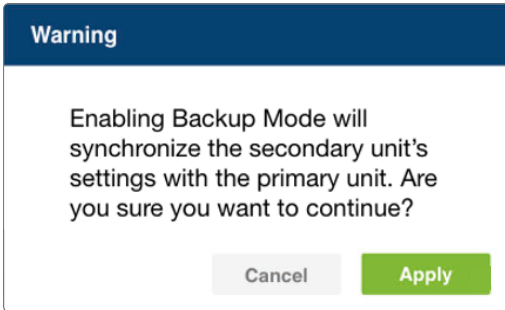

- ◆ Expansion Mode

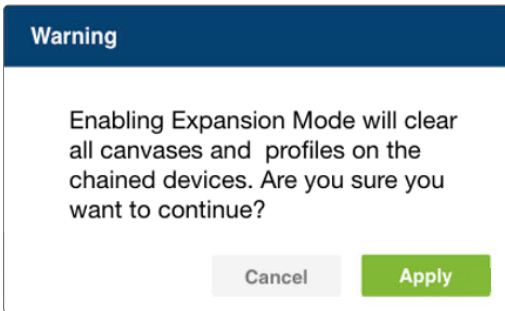

4. The **Chain Status** will change to **Syncing**, and the secondary unit(s) will begin synchronizing with the primary unit.

Chain Status: ● Syncing (Backup Mode) Refresh

| Order | Device Information | Status |
|-------------|-------------------------------|---------|
| Primary | Name (192.168.1.250)(Current) | Syncing |
| Secondary 1 | Name (192.168.1.251) | Syncing |
| Secondary 2 | -- | -- |

Chain Mode

Backup
▼

Enable
Disable

- Once synchronization is complete, the **Chain Status** will update to **Enable**, and all linked units will display **Working** in the status column.

Chain Status: ● Enable (Backup Mode) [Refresh](#)

| Order | Device Information | Status |
|-------------|-------------------------------|---------|
| Primary | Name (192.168.1.250)(Current) | Working |
| Secondary 1 | Name (192.168.1.251) | Working |
| Secondary 2 | -- | -- |

Chain Mode

Backup

Enable Disable

Disabling Chain Mode

To disable chaining:

- On primary unit's Web GUI, go to **Settings > Device Chain Configuration**.

- ◆ Back Mode:

Chain Status: ● Enable (Backup Mode) [Refresh](#)

| Order | Device Information | Status |
|-------------|-------------------------------|---------|
| Primary | Name (192.168.1.250)(Current) | Working |
| Secondary 1 | Name (192.168.1.251) | Working |
| Secondary 2 | -- | -- |

Chain Mode

Backup

Enable Disable

- ◆ Expansion Mode:

Chain Status: ● Enable (Expansion Mode) [Refresh](#)

| Order | Device Information | Status |
|-------------|-------------------------------|---------|
| Primary | Name (192.168.1.250)(Current) | Working |
| Secondary 1 | Name (192.168.1.251) | Working |
| Secondary 2 | -- | -- |

Chain Mode

Expansion

Enable Disable

2. Click **Disable** to revert the system to standalone mode.
3. A confirmation popup will be displayed. Click **Deactivate** to confirm.
 - ◆ Back Mode:

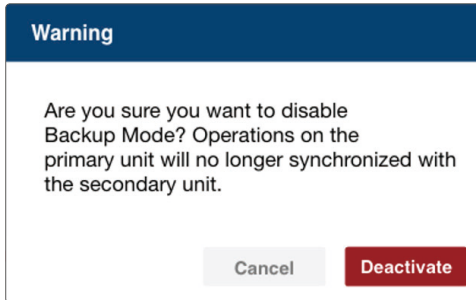

- ◆ Expansion Mode:

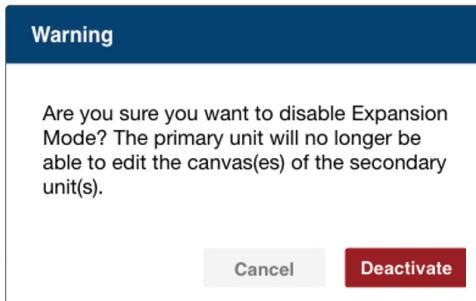

Chain Mode Behavior and UI Restrictions

In chained setups, the primary Web GUI retains full administrative control, while the secondary Web GUI functions primarily in a restricted, monitoring role. This separation ensures consistent configuration management and avoids conflicts in multi-unit environments.

Depending on the chain mode, user operations in the Web GUI vary:

| Chain Mode | Primary Web GUI | Secondary Web GUI (1 & 2) |
|-------------------|------------------------|--|
| Backup Mode | Full access | Limited. Design / Preview tabs are disabled unless the primary unit is offline |
| Expansion Mode | Full access to outputs | Limited. Editing disabled in Calendar & Design tabs |

- ◆ In **Backup Mode**, the secondary unit cannot be operated unless the primary unit is disconnected or fails.
- ◆ In **Expansion Mode**, only the primary unit handles output-related settings (e.g., HDCP, scaler, CEC). The secondary units can view outputs but not control them.

Backup Mode

Backup Mode provides redundancy and failover protection. When the primary unit becomes disconnected or fails, Secondary 1 automatically takes over, ensuring continuous system availability. This mode is designed for mission-critical environments where high reliability is required, such as command centers or surveillance control rooms.

To enable **Backup Mode**:

1. On the Primary Web GUI, go to **Settings > Device Chain Configuration**.
2. Verify that **Chain Status** is set to **Disable**.

The screenshot shows the 'Device Chain Configuration' interface. At the top, 'Chain Status' is set to 'Disable' with a radio button. A 'Refresh' button is visible to the right. Below this is a table with three columns: 'Order', 'Device Information', and 'Status'. The table contains three rows: 'Primary' (Name (192.168.1.250)(Current), --), 'Secondary 1' (Name (192.168.1.251), --), and 'Secondary 2' (--, --). Below the table is a 'Chain Mode' dropdown menu currently set to '-- / Backup (only support Primary & Secondary) / Expansion'. At the bottom, there are two buttons: 'Enable' (green) and 'Disable' (grey).

| Order | Device Information | Status |
|-------------|-------------------------------|--------|
| Primary | Name (192.168.1.250)(Current) | -- |
| Secondary 1 | Name (192.168.1.251) | -- |
| Secondary 2 | -- | -- |

Chain Mode: -- / Backup (only support Primary & Secondary) / Expansion

Buttons: Enable, Disable

3. In the **Chain Mode** dropdown menu, select **Backup Mode**.
4. Click **Enable**, then confirm in the warning popup by clicking **Apply**.

The warning dialog box has a dark blue header with the word 'Warning'. The main text reads: 'Enabling Backup Mode will synchronize the secondary unit's settings with the primary unit. Are you sure you want to continue?'. At the bottom, there are two buttons: 'Cancel' (grey) and 'Apply' (green).

Warning

Enabling Backup Mode will synchronize the secondary unit's settings with the primary unit. Are you sure you want to continue?

Buttons: Cancel, Apply

5. The **Chain Status** will briefly show **Syncing**, and once synchronization is complete, it changes to **Enable**, with both devices marked as **Working**.

Behavior and UI Restrictions

In **Backup Mode**, system control is centralized on the primary unit, while secondary unit remains in a restricted, monitoring-only role. This design ensures consistent configuration management and prevents conflicts, while providing an automatic failover mechanism if the Primary becomes unavailable.

- ◆ Primary Web GUI: Full administrative access.
- ◆ Secondary 1 Web GUI: Limited access.
 - ◆ Tabs such as **Design**, **Preview**, and **Calendar** are disabled.
 - ◆ Configuration is mirrored from the Primary.
- ◆ Only when the Primary goes offline or encounters an error does Secondary 1 temporarily inherit Primary-level control.

This design prevents dual-control risks while guaranteeing a seamless failover mechanism.

Recovery & Sync Notifications

In **Backup Mode**, the system provides automatic safeguards to ensure service continuity when the Primary unit becomes unavailable. Device connections and synchronization are constantly monitored in real time. If the Primary disconnects or encounters an error, the Secondary 1 unit immediately takes over as acting Primary to maintain operation. Once the Primary recovers, the system automatically re-synchronizes configurations across devices to restore consistency, without requiring manual intervention unless the sync fails.

- ◆ Primary disconnection:
 - ◆ A warning popup is displayed.

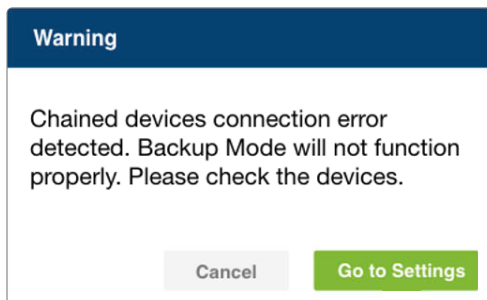

- ◆ Secondary 1 immediately takes over as acting Primary.

- ◆ Primary restored:
 - ◆ The system automatically triggers a re-sync process, ensuring configuration consistency across devices.
 - ◆ Both devices briefly show **Syncing**, then return to **Enable / Working**.
- ◆ No manual intervention is needed unless synchronization fails.

Expansion Mode

Expansion Mode is used to extend system output capacity by chaining multiple units together. This allows larger-scale video wall deployments while maintaining centralized management through the primary unit.

To enable **Expansion Mode**:

1. On the Primary Web GUI, go to **Settings > Device Chain Configuration**.
2. Verify that **Chain Status** is set to **Disable**.

The screenshot shows the 'Device Chain Configuration' interface. At the top, 'Chain Status' is set to 'Disable' with a radio button. A 'Refresh' link is visible. Below is a table with columns 'Order', 'Device Information', and 'Status'. The table lists 'Primary', 'Secondary 1', and 'Secondary 2' units. Below the table, 'Chain Mode' is set to 'Expansion' in a dropdown menu. At the bottom, there are 'Enable' and 'Disable' buttons.

| Order | Device Information | Status |
|-------------|-------------------------------|--------|
| Primary | Name (192.168.1.250)(Current) | -- |
| Secondary 1 | Name (192.168.1.251) | -- |
| Secondary 2 | -- | -- |

Chain Mode: -- / Backup (only support Primary & Secondary) / Expansion

Buttons: Enable, Disable

3. In the **Chain Mode** dropdown menu, select **Expansion Mode**.
4. Click **Enable**, then confirm in the warning popup by clicking **Apply**.

The warning dialog box has a dark blue header with the word 'Warning'. The main text reads: 'Enabling Expansion Mode will clear all canvases and profiles on the chained devices. Are you sure you want to continue?'. At the bottom, there are 'Cancel' and 'Apply' buttons.

5. The Chain Status will show **Syncing**, then change to **Enable** once synchronization is complete.

Behavior and UI Restrictions

In **Expansion Mode**, all units actively contribute to video output, but configuration authority remains centralized. The Primary unit retains full administrative rights, while Secondary units operate in a restricted, read-only capacity. This design ensures consistent management of display parameters and prevents conflicts across multiple devices.

- ◆ Primary Web GUI:
 - ◆ Full access to configure output-related parameters, including:
 - ◆ HDCP settings
 - ◆ Scaler resolution
 - ◆ CEC control
- ◆ Secondary Web GUI:
 - ◆ Read-only access.
 - ◆ Tabs such as **Design** and **Calendar** appear grayed out, with editing disabled.
 - ◆ Output mapping and canvas arrangements are visible but cannot be modified.

This ensures centralized governance of all configurations while preventing inconsistencies between units.

Recovery & Sync Notifications

In **Expansion Mode**, the system continuously monitors the status of all chained devices to maintain synchronized operation. If a secondary unit experiences a disconnection or error, or when the primary unit is restored, automatic synchronization mechanisms ensure configuration consistency across all units with minimal user intervention.

- ◆ If a Secondary disconnects or encounters an error, the system displays a warning popup and sets Chain Status to Error.

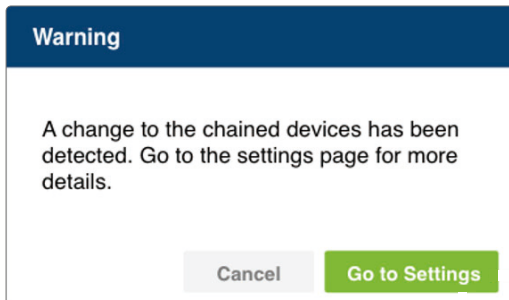

- ◆ When the Primary reconnects, the system automatically compares configuration timestamps and re-syncs all units.
- ◆ Devices briefly show Syncing, then return to Enable / Working once alignment is achieved.

Note: ◆ Once **Expansion Mode** is enabled, all canvases and profiles created in Standalone Mode are irreversibly cleared.

- ◆ When **Expansion Mode** is later disabled, the same clearing process applies—previous canvases and profiles cannot be restored.

This Page Intentionally Left Blank

Chapter 7

VW754 IP Streaming Card

Overview

The **VW754 IP Streaming Card** is a **4-channel H.265 IP Stream Decoder Input Card** for use with the Video Wall Processor. Each card supports up to four IP channels, allowing the system to decode and display video streams from RTSP, ONVIF, or ATEN Streaming Device sources. Multiple VW754 cards can be installed to expand IP streaming capacity for large-scale video wall deployments. System support varies by model; the VW3620 supports installation of up to five VW754 cards.

System Limitations

- ◆ A maximum of five VW754 cards per VW3620 unit.
- ◆ The total number of supported IP channels depends on the chassis model:
 - ◆ Up to 20 IP channels on the VW3620
 - ◆ Up to 16 IP channels on the VW1608
- ◆ 4 × 4 Multiview does not support single IP signals.
- ◆ Excess cards beyond five are blocked by the VW3620 system.
- ◆ All IP streams must comply with H.265 standards for compatibility.
- ◆ The decoder does not support B-frames or HEVC tile encoding. H.264/H.265 streams that use these features cannot be decoded or displayed.

Note: All screenshots and illustrations in this chapter use the VW3620 as an example. VW754 card behavior and functionality are identical on the VW1608, except for chassis-specific capacity limits.

Hardware Overview

VW754 Front View

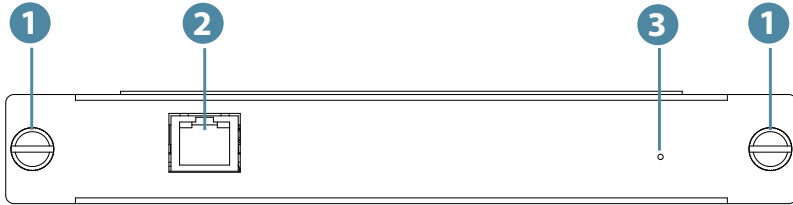

| No. | Componet | Description |
|-----|-------------|---|
| 1 | thumbscrews | Hand-tightened screws with ridged heads, used to secure components without tools. |
| 2 | LAN port | A Gigabit Ethernet port used to receive H.265 IP video streams from network sources such as IP cameras. |
| 3 | status LED | A green LED that indicates the unit is operating normally. |

Installation Capacity

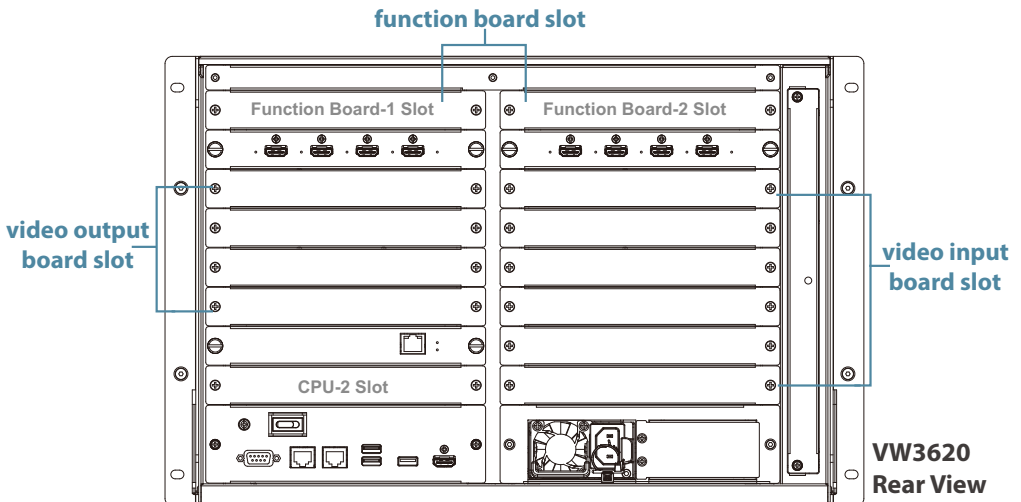

Each VW754 IP streaming card supports four channels. System capacity depends on the video wall processor model: the VW3620 supports up to five VW754 cards, providing a maximum of 20 IP channels, while the VW1608 supports up to four VW754 cards for a maximum of 16 IP channels.

Installing the VW754 IP Streaming Card

1. Remove the cover from an available board slot on the unit.
2. Insert the VW754 card into the input board slot until fully seated.
3. Press down on each thumbscrew head and tighten clockwise.
4. Repeat the steps to install additional VW754 cards if required.

Note: For the VW3620, installing more than five cards is not supported. The system will display a warning and block further usage.

Removing the VW754 IP Streaming Card

1. Loosen the thumbscrews alternately.
2. Hold both thumbscrews and gently pull out the VW754 card.

Design Mode – IP Card Tab Overview

Upon detection of a VW754 card, an IP Card tab is automatically added to the source list. Access the Video Wall Processor Web GUI to view and configure the available IP streaming sources.

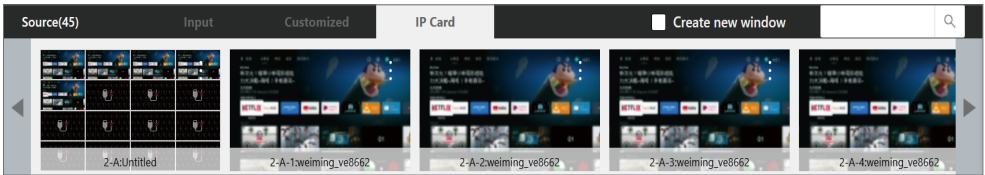

- ◆ Each installed VW754 card generates four inputs, automatically named using the format:
Slot name + hyphen (-) + A-D
Example: 2-B
 - ◆ Channels configured for multiview generate corresponding sub-sources, following the extended naming rule:
Slot name + hyphen (-) + A-D + number
Example: FN1-A-1, FN1-A-2
 - ◆ When a VW754 IP streaming card is installed in the VW3620, its input sources are organized under a dedicated source group.
 - ◆ **Group Level** (e.g., 2-B: Untitled):
This represents the aggregated view of all streaming sources from the installed VW754 card.
 - ◆ **Individual Sources** (e.g., 2-B-1, 2-B-2, 2-B-3, 2-B-4: DLINK-DCS5222L):
Each entry corresponds to one streaming input detected by the card. These are listed under the group and can be managed individually.
- The “2-B” entry represents the card-level source group, and “2-B-1 / 2-B-2” identify the individual streaming channels associated with that card. Input names are user-configurable.

Option Menu

From the IP Card tab, use the more button a source group or an individual source to open the options menu. The following operations are available:

- ◆ Source Group

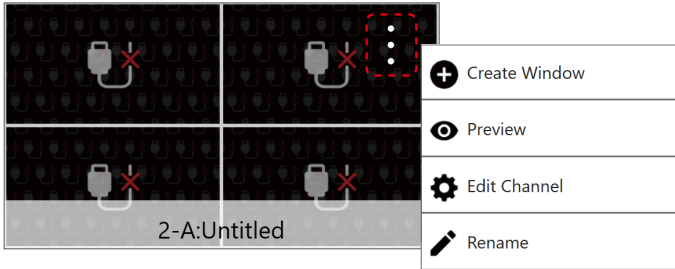

- ◆ Individual Streaming

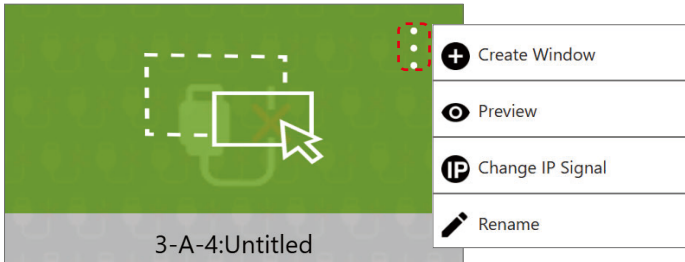

| Item | Description |
|------------------|--|
| Create Window | Creates a new display window for this video source within the current zone. |
| Preview | Opens a preview popup for this video source. |
| Edit Channel | Opens the Edit Channel popup window to modify this channel. See <i>Channel Configuration</i> , page 170 for details. |
| Change IP Signal | Opens the Change IP Signal popup, allowing you to change the streaming source via the dropdown menu. |
| Rename | Opens the Rename popup, where you can modify and confirm a new name for the selected input source. |

Channel Configuration

The **Edit Channel** popup provides the following configuration options:

| Item | Description |
|----------------------|---|
| Name | Specifies the channel name. You can enter a custom identifier to make the source easier to recognize in the interface. |
| Number of IP Signals | Specifies how many signals are assigned. The resolution list updates dynamically based on the number of signals selected. |
| Audio Selection | Determines which IP signal provides the audio for this channel. By default, the system assigns IP Signal 1, but you can select any available signal from the dropdown list. |
| IP Signal | Chooses from existing IP signals or add new ones. Audio channel selection is supported. |

Design Mode – Multiview Integration

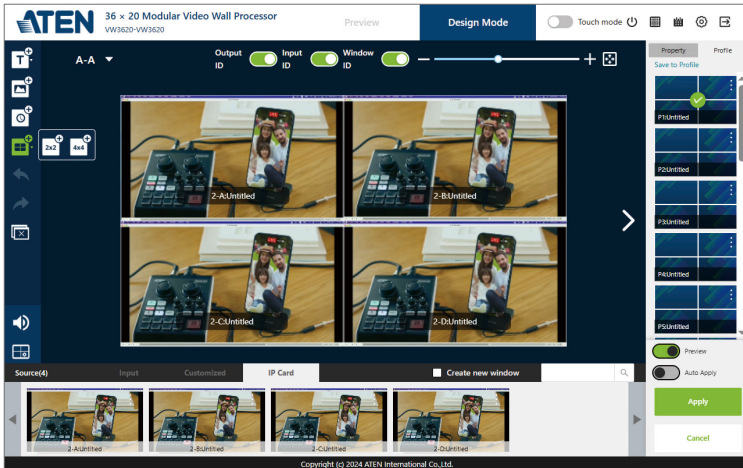

In **Design Mode**, IP signals can also be integrated into multiview layouts. The behavior varies depending on the selected multiview configuration:

2 x 2 Multiview

IP signals may be added directly as input sources through the source selection menu. Drag-and-drop operations are supported within the editor, allowing you to replace or rearrange sources in the layout in the same way as HDMI inputs.

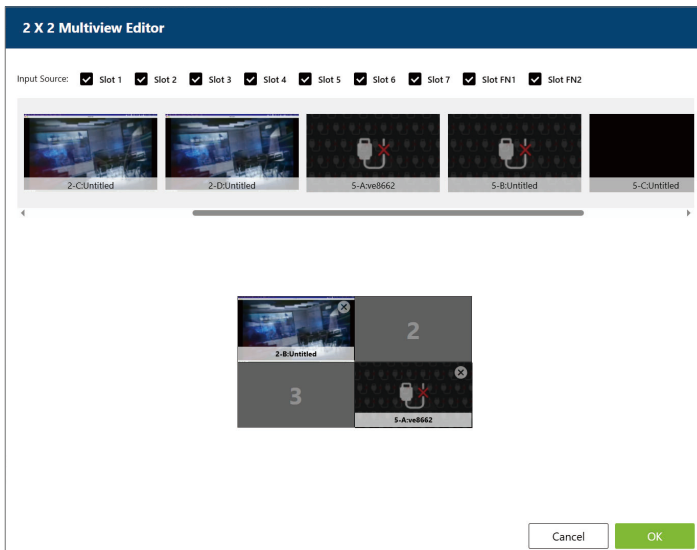

4 × 4 Multiview

Only IP channels are supported. Single IP signals cannot be added, and unsupported entries will appear grayed out. When hovering the cursor over these entries, a tooltip notification appears stating that single IP signal sources are not supported. Users must select another valid input source.

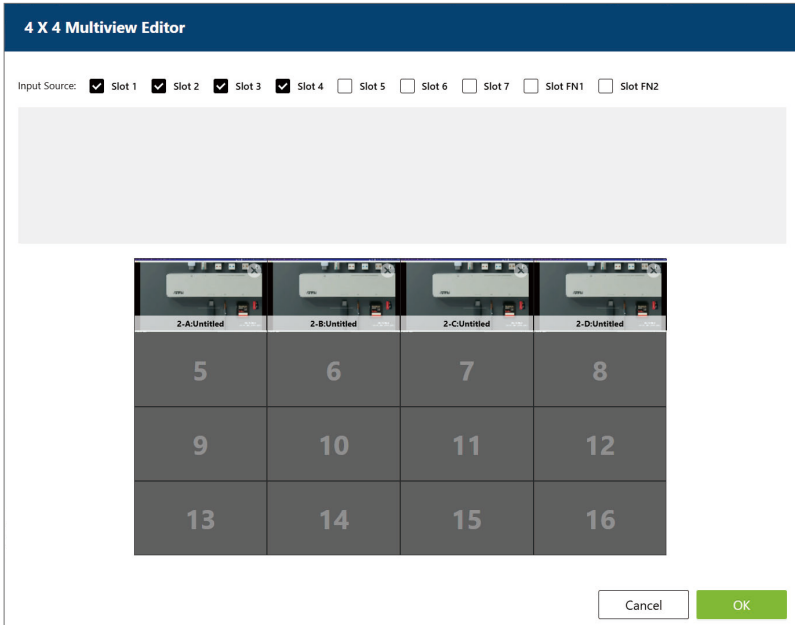

Limitations

The following restrictions apply when integrating IP signals into Multiview layouts:

- The 4 × 4 Multiview editor does not support adding single IP signals.
- Adding a large number of IP signals may increase processing load and could affect performance.

VW754 IP Channels in Source Array

When a VW754 IP streaming card is installed, the **Source Array** page also displays its IP channels alongside the HDMI inputs.



- ◆ Each VW754 card provides four preview windows, corresponding to its four IP channels.
- ◆ These previews allow users to check stream availability and status without loading the sources into a canvas, offering a quick way to confirm whether the IP streams are online or inactive.
- ◆ Unavailable channels are shown as grayed-out entries with status indicators for easy identification.

Note: The previews for VW754 IP channels are integrated into the same **Source Array** page as VW784 input cards, but are described separately here because VW754 is an optional accessory.

IP Signal Management

Navigate to **Settings > Port Settings > IP Signal Management** to add or modify IP signals from the installed VW754 IP streaming card(s).

| Name | Type | IP / URL | Username | Password |
|----------------|-------|----------------------------------|----------|----------|
| DLINK-DCSS222L | RTSP | rtsp://192.168.252.27/live1.sdp | benson | ***** |
| test src 01 | RTSP | rtsp://192.168.214.209/mystream1 | | |
| test src 02 | RTSP | rtsp://192.168.214.209/mystream2 | | |
| DCSS222LB | Onvif | 192.168.252.27 | benson | ***** |
| ATENVE8662 | ATEN | rtsp://192.168.214.209 | | |
| error_onvif | Onvif | 192.168.55.55 | error | ***** |

Copyright (c) 2024 ATEN International Co., Ltd.

The **IP Signal Management** page itemizes all the input sources from the installed VW754 streaming cards, with the following information:

| Item | Description |
|----------|---|
| Name | The identifier of the IP signal. You can enter a custom name to make the source easier to recognize when adding a new source / editing a existing source. |
| Type | The protocol or format used by the IP signal. |
| IP / URL | The IP address or URL path used to connect to the streaming source. |
| Username | The login name required to access the IP signal, if authentication is enabled. |
| Password | The login password corresponding to the username. For security, the password is displayed as hidden characters. |

Adding a New IP Signal

To add a new IP signal, click the **+ Add IP Signal** button to open the **Add IP Signal** popup, and select one of the following protocols: RTSP, Onvif, or ATEN Streaming Device.

Add IP Signal

Protocol

RTSP
▼

Name

Untitled

URL

rtsp://

Port

Username

Password

Cancel

OK

| Protocol | Description |
|-----------------------|---|
| RTSP | Adds an IP signal using the Real-Time Streaming Protocol. Enter the stream URL, port, and authentication details as required. |
| Onvif | Adds an IP signal from an Onvif-compliant device. The signal can be discovered automatically or added manually by specifying the device IP and login credentials. |
| ATEN Streaming Device | Adds an IP signal from an ATEN streaming device (e.g., VE8662). Enter the device IP, port, and authentication details to establish the connection. |

RTSP

Use this option to add an IP signal through the Real-Time Streaming Protocol (RTSP). This method requires the stream URL and, if applicable, authentication credentials.

- ◆ **Protocol:**
Selects RTSP as the streaming protocol.
- ◆ **Name:**
Specifies a custom name for the IP signal. This helps identify the source in the management list.
- ◆ **URL:**
Defines the RTSP stream address (e.g., `rtsp://<IP>/<path>`).
- ◆ **Port:**
The network port used for the RTSP stream.
- ◆ **Username:**
The login name required to access the RTSP stream, if authentication is enabled.
- ◆ **Password:**
The corresponding password for the username

Onvif

Use this option to add an IP signal from an Onvif-compliant device. You can either configure the device manually or let the system automatically discover available signals on the network.

Add IP Signal

Protocol
Onvif

Name
Untitled

Method
Manual

Device IP

Username

Password

Cancel OK

- ◆ Protocol:
Selects **Onvif** as the streaming protocol.
- ◆ Name:
Specifies a custom name for the IP signal. This helps identify the source in the management list.
- ◆ Method:
 - ◆ Manual:
Enter the device IP and authentication details manually.

- ◆ **Auto scan:**
Automatically searches for Onvif devices in the network. Select one or more discovered devices and assign credentials to complete the setup.

Add IP Signal

Protocol
Onvif

Method
Auto scan

Select All Deselect All

| | | | |
|--------------------------|----------------|----------|--------------|
| <input type="checkbox"/> | 192.168.252.27 | Untitled | Credential 1 |
|--------------------------|----------------|----------|--------------|

Set Account Credentials [Add New Credential Set](#)

Credential 1 [Apply to All](#)

Username

Password

Cancel OK

- ◆ **Device IP:**
Defines the device IP for the Onvif signal. This option is available when using **Manual** mode.
- ◆ **Username:**
The login name required to access the Onvif device.
- ◆ **Password:**
The corresponding password for the username.
- ◆ **Set Account Credentials (Auto scan mode only):**
Defines or applies login credentials to the discovered devices.

ATEN Streaming Device

Use this option to add an IP signal from an ATEN streaming device, such as the VE8662. You can configure the device manually or allow the system to automatically discover available devices on the network.

Add IP Signal

Protocol

ATEN Streaming Device

Name

Untitled

Method

Manual

Device IP

rtsp://

Port

8554

Username

Password

Cancel OK

- ◆ Protocol:
Selects **ATEN Streaming Device** as the protocol.
- ◆ Name:
Specifies a custom name for the IP signal (available in **Manual** mode).

- ◆ Method:
 - ◆ Manual:

Enter the device IP, port, and authentication details manually.
 - ◆ Auto scan:

Automatically detects ATEN streaming devices in the network. Select one or more devices from the list and assign credentials to complete the setup.

Add IP Signal

Protocol

ATEN Streaming Device
▼

Method

Auto scan
▼
↻

Port

8554

[Select All](#) [Deselect All](#)

| | | |
|--|----------|----------------|
| <input type="checkbox"/> 192.168.215.119 | Untitled | Credential 1 ▼ |
| <input type="checkbox"/> 192.168.235.253 | Untitled | Credential 1 ▼ |
| <input type="checkbox"/> 192.168.183.198 | Untitled | Credential 1 ▼ |
| <input type="checkbox"/> 192.168.236.4 | Untitled | Credential 1 ▼ |

Set Account Credentials [Add New Credential Set](#)

Credential 1 [Apply to All](#)

Username

Password

👁

Cancel

OK

- ◆ **Device IP:**
Enter the IP address of the ATEN streaming device. This field is available only in Manual mode.
- ◆ **Port:**
The network port used by the ATEN streaming device.
- ◆ **Username:**
The login name required to access the device.
- ◆ **Password:**
The corresponding password for the username.
- ◆ **Set Account Credentials (Auto scan mode only):**
Defines or applies login credentials to the discovered devices.

Editing an Existed IP Signal

| IP Signal Management + Add IP Signal | | | | |
|---|-------|----------------------------------|----------|----------------------|
| Name | Type | IP / URL | Username | Password |
| DLINK-DCS5222L | RTSP | rtsp://192.168.252.27/live1.sdp | benson | ***** |
| test src 01 | RTSP | rtsp://192.168.214.209/mystream1 | | |
| test src 02 | RTSP | rtsp://192.168.214.209/mystream2 | | Edit |
| DCS5222LB | Onvif | 192.168.252.27 | benson | ***** |
| ATENVE8662 | ATEN | rtsp://192.168.214.209 | | |
| error_onvif | Onvif | 192.168.55.55 | error | ***** |

Hover over the IP streaming source to be edited, and the **Edit** option will appear. Click **Edit** to open the **Edit IP Signal** window, make the necessary changes, and click **OK** to save. Note that the **Protocol** field is fixed and cannot be modified. To use a different protocol, delete the existing entry and add a new IP signal.

Edit IP Signal

Protocol

Onvif
▼

Name

Device IP

Username

Password

Delete

Cancel

OK

To remove an IP streaming source, click the **Delete** button.

Connection Status

The screenshot displays the 'Connections' page of the ATEN 36 x 20 Modular Video Wall Processor (VW3620-VW3620). The page features a navigation bar with 'General', 'Port Settings', 'Status', and 'Maintenance' tabs. The 'Status' tab is active, showing a 'Working' indicator (green square). A 'Refresh' button is located in the top right corner. The main content area is divided into two columns: 'Output' and 'Input'. The 'Output' column includes 'IN FN1', 'OUT 2', 'OUT 3', 'OUT 4', 'OUT 5', 'CPU 1', and 'CPU 2'. The 'Input' column includes 'IN FN2' (displaying 37°C), 'IN 1', 'IN 3', 'IN 4', 'IN 5', 'IN 6', 'IN 7', 'POWER1', and 'POWER2'. Each component has a status indicator (green for working, red for alarm, grey for N/A) and a fan icon. At the bottom of the page, there is a copyright notice: 'Copyright (c) 2024 ATEN International Co., Ltd.'.

Go to **Settings > Status**. The **Connections** page provides the real-time status of the installed components, which may include the following depending on your installation:

- ◆ VW784 input card
- ◆ VW884 output card
- ◆ VW754 IP streaming card
- ◆ Power module
- ◆ CPU board
- ◆ Fan module

See *Status*, page 113 for details.

Clicking on a VW754 IP streaming card opens the information window with the following details:

 **Streaming Card 2**
✕

Working Status: Normal

| Model Name | FW Version | Temperature | Power |
|------------|------------|-------------|-----------|
| VW754 | V1.0.067 | 33°C | MAX .48 W |

| | IP | MAC | Mask | Gateway |
|----------|-----------------|-------------------|-------------|--------------|
| A | 192.168.171.180 | 00:10:74:6b:fe:49 | 255.255.0.0 | 192.168.50.1 |
| B | 192.168.171.181 | 00:10:74:6b:fe:4a | 255.255.0.0 | 192.168.50.1 |
| C | 192.168.171.182 | 00:10:74:6b:fe:4b | 255.255.0.0 | 192.168.50.1 |
| D | 192.168.171.183 | 00:10:74:6b:fe:4c | 255.255.0.0 | 192.168.50.1 |

| Information | Description |
|-------------|--|
| Model Name | Displays the model identifier of the installed streaming card. |
| FW Version | Shows the current firmware version running on the card. |
| Temperature | Indicates the real-time operating temperature of the card. |
| Power | Displays the maximum power consumption of the card. |
| IP | Lists the IP addresses assigned to each channel (A–D). |
| MAC | Shows the unique MAC addresses corresponding to each IP channel. |
| Mask | Displays the subnet mask used for network configuration. |
| Gateway | Shows the default gateway address assigned to the card. |

Power Consumption and Warnings

The system monitors the power consumption of installed components and provides warnings when thresholds are exceeded.

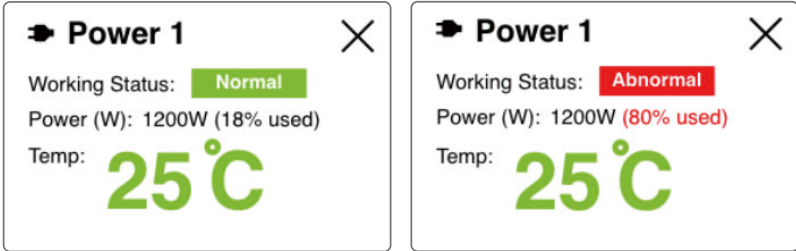

- ◆ Power usage is calculated as a percentage of rated capacity.
- ◆ If the power consumption rises above 80%, the system marks the status in red to highlight high usage.
- ◆ Installing more than five VW754 cards may cause warnings and prevent operation.

IP Card Network Settings

ATEN 36 x 20 Modular Video Wall Processor
VW3620-VW3620

General Port Settings Status Maintenance

IN2:VW754

Mode
 DHCP Manual

IP Address-A
192.168.171.180

IP Address-B
192.168.171.181

IP Address-C
192.168.171.182

IP Address-D
192.168.171.183

Mask
255.255.0.0

Gateway
192.168.50.1

DNS

Cancel Save

Each installed VW754 card is assigned its own network configuration entry under **Settings > Maintenance > Network**.

The IP address can be obtained automatically through DHCP, or specified manually under Manual mode. Its network configuration fields are:

- ◆ **Mode**
Select how the IP address is assigned:
 - ◆ DHCP: The IP address is automatically obtained from the network.
 - ◆ Manual: Specify all network parameters manually.
- ◆ **IP Address-A / B / C / D**
Assign individual IP addresses for each channel (A–D) of the VW754 card.
- ◆ **Mask**
Define the subnet mask used for the network configuration.
- ◆ **Gateway**
Specify the default gateway address for network routing.

- ◆ DNS
(Optional) Enter the DNS server address if domain name resolution is required.

For each installed VW754 card, an additional configuration entry is created. Scroll down the Network page to locate and adjust the settings for the desired card.

This Page Intentionally Left Blank

Chapter 8

CLI Commands

Overview

The Video Wall Processor can be configured and controlled via RS-232 or Telnet commands when connected to a host computer or other device, such as a control system. This chapter provides information on how to connect to the Video Wall Processor via RS-232/Telnet and command syntax.

Connecting to the Video Wall Processor via Telnet

To establish a Telnet session with the Video Wall Processor, do the following:

1. Connect a host computer or control system to a shared network with the Video Wall Processor.
2. Open a command-line interpreter program from your computer.
3. In the command-line interpreter, type the Video Wall Processor's IP address in the following way:

```
telnet [IP address]:23
```

4. Press **Enter**. The login screen appears.
5. At the login prompt, type the login username and password for the Video Wall Processor.
6. When a session is established with the Video Wall Processor, you can control and configure the Video Wall Processor via RS-232 commands. For more information on commands, see *Commands*, page 193.

Note: If a user logs in using a username that is already in session, the newest login takes effect and the previous session will be replaced.

Connecting to the Video Wall Processor via RS-232

You can control and operate the Video Wall Processor using a high-end controller or PC. To connect to the VW3620 via RS-232, do the following:

1. Connect the RS-232 serial port on the Video Wall Processor to the RS-232 serial port on your computer using a 9-wire straight cable, with only pin 2 to pin 2, pin 3 to pin 3, and pin 5 to pin 5 connected.

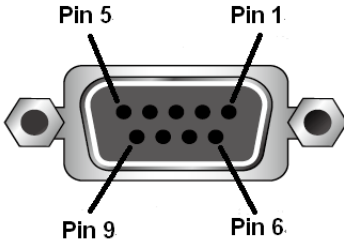

| Pin | Description |
|-----|---------------|
| 1 | Not connected |
| 2 | RXD |
| 3 | TXD |
| 4 | Not connected |
| 5 | GND |
| 6 | Not connected |
| 7 | Not connected |
| 8 | Not connected |
| 9 | Not connected |

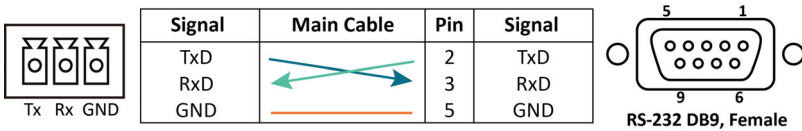

2. The controller's serial port should be configured as follows:

| RS-232 Protocol | |
|-----------------|-------|
| Baud Rate | 19200 |
| Data Bits | 8 |
| Parity | None |
| Stop Bits | 1 |
| Flow Control | None |

3. When a session is established with the VW3620, you can control and configure the VW3620 via RS-232 commands. For more information on commands, see *Commands*, page 193.

Command Guidelines

- ◆ The general form of a command is:

```
command parameter<argument> {one|two|three}
```

| Notation | Description |
|----------------|--|
| command | The name of the command is shown in bold. |
| parameter | Indicates the name of the parameter. |
| <argument> | Indicates the name of the value or the information that the user must provide. Only type the information in the angle brackets, not the brackets themselves. |
| [] | Indicates keys you should press. For example, [Enter] means to press the Enter key. If keys need to be chorded, they appear together in the same bracket with a plus sign between them: [Ctrl+Alt]. |
| { } | Indicates a set of choices from which the user must choose one. |
| | Indicates two or more mutually exclusive choices in a command line. Only type one of the choices in the command line, not the symbol. |

- ◆ If you have two or more parameters, the order of these parameters among themselves does not affect the result of the operation. For example, both of the following commands execute the same task:

```
command name + parameter 1 + parameter 2
```

```
command name + parameter 2 + parameter 1
```

Verification

After entering a command, a verification message appears at the end of the command line as follows:

- ◆ **Command OK**—indicates that the command is correct and successfully performed by the switch
- ◆ **Command incorrect**—indicates that the command has the wrong format and/or values.

Commands

After connecting to the Video Wall Processor via Telnet or RS-232, you can operate the system using the following commands.

-
- Note:**
- ◆ CLI command of LED mode is the same as Wall mode.
 - ◆ "Window ID" commands can work if zone is defined as Video Wall Mode and LED mode.
 - ◆ "Output ID" commands can work if zone is defined as Independent Mode.
-

Switch Port Command

Switch a specific input video source to a specific output port(s) / window(s) displayed on a designated zone.

The formula for Switch commands are as follows:

- ◆ **sw** z<zone ID> o<output ID> i<input ID> [ENTER]
- ◆ **sw** z<zone ID> ow<window ID> i<input ID> [ENTER]

Parameters:

- ◆ z<zone ID>
 - ◆ **Description:** Specify the zone to be displayed
 - ◆ **Format:** a to d
- ◆ o<output ID>
 - ◆ **Description:** Specify the output port
 - ◆ **Format:**
 - ◆ **VW3620:** 1-a to 5-d
 - ◆ **VW1608:** 1-a to 2-d
 - ◆ an asterisk * means all the output ports
- ◆ ow<window ID>
 - ◆ **Description:** Specify the output window
 - ◆ **Format:** 1 to 144 ; an asterisk * means all the output windows

- ◆ `i<input ID>`
 - ◆ **Description:** Specify the input port of the target source
 - ◆ **Format:**
 - ◆ **VW3620:** 1-a to fn2-d
 - ◆ **VW1608:** 1-a to 4-d

Example:

1. To switch input port fn-1a to output port 4-a, and display on zone c, type the following:
`sw zc o4-a ifn1-a [Enter]`
2. To switch input port 3-b to all the output windows displayed on zone c, type the following:
`sw zc ow* i3-b [Enter]`
3. To switch input port fn2-a to all the output ports, and display one zone b, type the following:
`sw zb o* ifn2-a [Enter]`

Load Profile Commands

The Load Profile command allows you to apply one or multiple profiles to the display zones. The formula for Load Profile command is as follows:

- ◆ **profile** f<profile ID> z<zone ID> load [ENTER]

Parameters:

- ◆ f<profile ID>
 - ◆ **Description:** Specify the profile to be applied
 - ◆ **Format:** 1 to 24
- ◆ z<zone ID>
 - ◆ **Description:** Specify the display zone that applies the designated profile
 - ◆ **Format:** 1 to 4

Example:

1. To apply profile 4 to zone 2, type the following:
profile f4 z2 load [Enter]

Move Window Command

Move and/or resize a specific window within a designated display zone.

The formula for the Move command is as follows:

- ◆ **winctrl** z<zone ID> w<window ID> pos<x,y>
[size<width,height>] [ENTER]

Parameters:

- ◆ z<zone ID>
 - ◆ **Description:**
Specify the display zone where the target window is located
 - ◆ **Format:** a to d
- ◆ w<window ID>
 - ◆ **Description:**
Specify the output window to be moved or resized
 - ◆ **Format:** 001 to 144
- ◆ pos<x, y>
 - ◆ **Description:**
Specify the new position of the window within the zone
 - ◆ **Format:**
x, y are based on the total resolution of the video wall layout

Example:

1. To move window 1 in zone a to position (1920, 1080), type:
winctrl za w001 pos1920,1080 [Enter]

2. To move and resize window 1 in zone a, type the following:
winctrl za w001 pos1920,1080 size1280,720 [Enter]

Create New Window Command

Create a new window in a specified zone and assign an input source with a defined position and size.

The formula for the New Window command is as follows:

- ◆ **winctrl** z<zone ID> i<input ID> pos<x,y>
size<width,height> [ENTER]

Parameters:

- ◆ z<zone ID>
 - ◆ **Description:**
Specify the display zone where the new window is created
 - ◆ **Format:** a to d
- ◆ i<input ID>
 - ◆ **Description:**
Specify the input source assigned to the new window
 - ◆ **Format:**
 - ◆ **VW3620:** 1-a to fn2-d
 - ◆ **VW1608:** 1-a to 4-d
- ◆ pos<x,y>
 - ◆ **Description:**
Specify the position of the new window within the zone
 - ◆ **Format:**
x, y are based on the total resolution of the video wall layout
- ◆ size<width,height>
 - ◆ **Description:**
Specify the size of the new window.
 - ◆ **Format:**
width,height are based on the total resolution of the video wall layout.

Example:

1. To create a new window in zone b using input port 2-a at position (0,0) with a size of 1920 × 1080, type the following:

```
winctrl zb i2-a pos0,0 size1920,1080 [Enter]
```

EDID Mode Command

Extended Display Identification Data (EDID) is a data that contains a display's basic information and is used to communicate with the video source. The EDID Mode commands allow you to change the EDID setting.

The formula for the EDID command is as follows:

◆ `edid port1|default|custom [ENTER]`

Parameters:

- ◆ `port1`
Set all ports' EDID is the same as Port1's EDID.
- ◆ `default`
Set all ports' EDID to be the same as the hardware default EDID.
- ◆ `custom`
Implement the customized mode as set in the EDID system settings.
See *EDID Mode*, page 109, for details.

Example:

1. To use the default mode, type:
`edid default [Enter]`
2. To use Port1 EDID mode, type:
`edid port1 [Enter]`

CEC Command

Consumer Electronics Control (CEC) allows interconnected HDMI devices to communicate and respond to the same remote control.

The formula for the CEC commands are as follows:

- ◆ **cec** o<output ID> on|off [ENTER]
- ◆ **cec** z<zone ID> on|off [ENTER]

Parameters:

- ◆ o<output ID>
 - ◆ **Description:** Specify the output port
 - ◆ **Format:**
 - ◆ **VW3620:** 1 to 20
 - ◆ **VW1608:** 1 to 8
- ◆ z<zone ID>
 - ◆ **Description:** Specify the display zone
 - ◆ **Format:** 1 to 4

Example:

1. To enable / disable the CEC function for a specific output port in independent mode:

```
cec o05 off [Enter]
```

```
cec o09 on [Enter]
```

2. To enable / disable the CEC function for a specific zone in wall / LED mode:

```
cec z02 on [Enter]
```

```
cec z02 off [Enter]
```

Read Command

The Read command allows you to view information about the devices, including the model name, the firmware version, the serial number, and the MAC address. The formula for the Read command is as follows:

♦ **read** [Enter]

Example:

1. To view information of the Video Wall Processor, type:

```
read [Enter]
```

Reset Command

The Reset command allows you to reset the Video Wall Processor back to the default factory settings. Reset includes resetting the devices IP address.

The formula for the Reset command is as follows:

♦ **reset** [Enter]

Example:

1. To reset the Video Wall Processor, type:

```
reset [Enter]
```

Reboot Command

The Reboot command allows you to turn off the Video Wall Processor and then start it again immediately. The formula for the Reset command is as follows:

♦ **reboot** [Enter]

Example:

1. To reboot the Video Wall Processor, type:

```
reboot [Enter]
```

Baud Rate Command

The Baud Rate command allows you to set the RS-232 data rate for the Video Wall Processor to use. Options are 9600, 19200 (default) 38400 and 115200.

The formula for the Baud Rate command is as follows:

```
baud 9600|19200|38400|115200 [Enter]
```

Parameters:

- ◆ 9600
- ◆ 19200
- ◆ 38400
- ◆ 115200

Example:

1. To set 38400 as the baud rate, type:

```
baud 38400 [Enter]
```

Echo Command

The Echo function updates the RS232 controller when operations are made via the front panel pushbuttons, web browser or telnet. The changes echo back to the RS-232 controller to keep the settings in sync with the device.

The formula for the Echo command is as follows:

```
echo on|off [Enter]
```

Parameters:

- ◆ on
Enable the echo feature.
- ◆ off
Disable the echo feature.

Example:

1. For example, to enable the echo feature, type:

```
echo on [Enter]
```

Fan Speed Command

The Fan Speed command allows you to set the Video Wall Processor's internal fan speed.

To set the fan speed, use the following command:

- ◆ **fan** mid|high|auto [Enter]

Parameters:

- ◆ mid
Set internal fan to normal speed.
- ◆ high
Set internal fan to high speed.
- ◆ auto
Set internal fan to auto detect (default).

Example:

1. To set the fan to auto detect, type:
fan auto [Enter]

Alert Command

To trigger a warning when issues arise for a specific window, use the following command:

- ◆ **alert** z<zone ID> w<window ID> on|off [Enter]

Parameters:

- ◆ z<zone ID>
 - ◆ **Description:** Specify the display zone
 - ◆ **Format:** 1 to 4
- ◆ w<window ID>
 - ◆ **Description:** Specify the output window
 - ◆ **Format:** 1 to 144 ; an asterisk * means all the output windows
- ◆ on
Enable the alert feature.
- ◆ off
Disable the alert feature.

Example:

1. To enable the Alert function for window 5 on zone 1, type:

```
alert z1 w5 on
```
2. To disable the Alert function for window 3 on zone 2, type:

```
alert z2 w3 off
```

Standby Mode Command

Standby mode is a power-saving mode that shuts parts of the system down to allow the user to quickly resume operation when needed.

The formula for the standby mode command is as follows:

- ◆ **standby** on|off [Enter]

Parameters:

- ◆ on
Turn on the standby mode.
- ◆ off
Turn off the standby mode.

Example:

1. To enable standby mode, type the following:
standby on [Enter]

Safety Instructions

General

- ◆ Read all of these instructions. Save them for future reference.
- ◆ Follow all warnings and instructions marked on the device.
- ◆ This product is for indoor use only.
- ◆ Do not place the device on any unstable surface (cart, stand, table, etc.). If the device falls, serious damage will result.
- ◆ Do not use the device near water.
- ◆ Do not place the device near, or over, radiators or heat registers.
- ◆ The device cabinet is provided with slots and openings to allow for adequate ventilation. To ensure reliable operation, and to protect against overheating, these openings must never be blocked or covered.
- ◆ The device should never be placed on a soft surface (bed, sofa, rug, etc.) as this will block its ventilation openings. Likewise, the device should not be placed in a built in enclosure unless adequate ventilation has been provided.
- ◆ Never spill liquid of any kind on the device.
- ◆ Unplug the device from the wall outlet before cleaning. Do not use liquid or aerosol cleaners. Use a damp cloth for cleaning.
- ◆ The device should be operated from the type of power source indicated on the marking label. If you are not sure of the type of power available, consult your dealer or local power company.
- ◆ The device is designed for IT power distribution systems with 230V phase-to-phase voltage.
- ◆ To prevent damage to your installation it is important that all devices are properly grounded.
- ◆ The device is equipped with a 3-wire grounding type plug. This is a safety feature. If you are unable to insert the plug into the outlet, contact your electrician to replace your obsolete outlet. Do not attempt to defeat the purpose of the grounding-type plug. Always follow your local/national wiring codes.
- ◆ Do not allow anything to rest on the power cord or cables. Route the power cord and cables so that they cannot be stepped on or tripped over.

- ◆ If an extension cord is used with this device make sure that the total of the ampere ratings of all products used on this cord does not exceed the extension cord ampere rating. Make sure that the total of all products plugged into the wall outlet does not exceed 15 amperes.
- ◆ To help protect your system from sudden, transient increases and decreases in electrical power, use a surge suppressor, line conditioner, or un-interruptible power supply (UPS).
- ◆ Position system cables and power cables carefully; Be sure that nothing rests on any cables.
- ◆ Never push objects of any kind into or through cabinet slots. They may touch dangerous voltage points or short out parts resulting in a risk of fire or electrical shock.
- ◆ Do not attempt to service the device yourself. Refer all servicing to qualified service personnel.
- ◆ If the following conditions occur, unplug the device from the wall outlet and bring it to qualified service personnel for repair.
 - ◆ The power cord or plug has become damaged or frayed.
 - ◆ Liquid has been spilled into the device.
 - ◆ The device has been exposed to rain or water.
 - ◆ The device has been dropped, or the cabinet has been damaged.
 - ◆ The device exhibits a distinct change in performance, indicating a need for service.
 - ◆ The device does not operate normally when the operating instructions are followed.
- ◆ Only adjust those controls that are covered in the operating instructions. Improper adjustment of other controls may result in damage that will require extensive work by a qualified technician to repair.
- ◆ Avoid circuit overloads. Before connecting equipment to a circuit, know the power supply's limit and never exceed it. Always review the electrical specifications of a circuit to ensure that you are not creating a dangerous condition or that one does not already exist. Circuit overloads can cause a fire and destroy equipment.

Rack Mounting

- ◆ Before working on the rack, make sure that the stabilizers are secured to the rack, extended to the floor, and that the full weight of the rack rests on the floor. Install front and side stabilizers on a single rack or front stabilizers for joined multiple racks before working on the rack.
- ◆ Always load the rack from the bottom up, and load the heaviest item in the rack first.
- ◆ Make sure that the rack is level and stable before extending a device from the rack.
- ◆ Do not overload the AC supply branch circuit that provides power to the rack. The total rack load should not exceed 80 percent of the branch circuit rating.
- ◆ Make sure that all equipment used on the rack – including power strips and other electrical connectors – is properly grounded.
- ◆ Ensure that proper airflow is provided to devices in the rack.
- ◆ Ensure that the operating ambient temperature of the rack environment does not exceed the maximum ambient temperature specified for the equipment by the manufacturer.
- ◆ Do not step on or stand on any device when servicing other devices in a rack.

Technical Support

International

- ◆ For online technical support – including troubleshooting, documentation, and software updates: <http://eservice.aten.com>
- ◆ For telephone support, see *Telephone Support*, page iv:

North America

| | | |
|--------------------------|--|---|
| Email Support | | support@aten-usa.com |
| Online Technical Support | Troubleshooting Documentation Software Updates | http://www.aten-usa.com/support |
| Telephone Support | | 1-888-999-ATEN ext 4988 |

When you contact us, please have the following information ready beforehand:

- ◆ Product model number, serial number, and date of purchase.
- ◆ Your computer configuration, including operating system, revision level, expansion cards, and software.
- ◆ Any error messages displayed at the time the error occurred.
- ◆ The sequence of operations that led up to the error.
- ◆ Any other information you feel may be of help.

Specifications

VW1608

| Input and Output Boards | |
|-------------------------|--|
| Board Input | 4 × Slot, up to 32 4K inputs Note: The top 2 Slots can used for Function Board |
| Board Output | 2 × Slot, up to 8 4K outputs |
| Video Input | |
| Interfaces | Depends on which I/O board is inserted |
| Video Output | |
| Interfaces | Local Output: 1 × HDMI Type A Female (Black) |
| Control | |
| RS-232 | <ul style="list-style-type: none"> ◆ Connector: 1 × DB-9 Female (Black) ◆ Serial Control Pin Configurations: <ul style="list-style-type: none"> ◆ Pin2 = Tx ◆ Pin 3=Rx ◆ Pin 5= Gnd ◆ Baud Rate and Protocol: <ul style="list-style-type: none"> ◆ Baud Rate: 19200 Data Bits: 8 Stop Bits: 1 Parity: No Flow Control: No |
| Ethernet | Connector: 1 × RJ-45 Female |
| USB | 3 × USB Type A Female (White) Note: Currently the USB ports support storage and firmware upgrade. |
| EDID Settings | |
| EDID Mode | Default / Port1 / Customized (EDID Wizard support) |
| Communication | |
| Daisy Chain Ports | RJ-45 × 2 |

| Connectors | |
|----------------------------|---|
| Power | 1 × 3-Prong AC Socket |
| Power | |
| Maximum Input Power Rating | 100–240V~, 50/60Hz, 7.0–3.5A × 2 |
| Consumption | AC110V; 550W; 326BTU/h AC220V; 550W; 324BTU/h Note: <ul style="list-style-type: none"> ◆ The measurement in Watts indicates the typical power consumption of the device with no external loading. ◆ The measurement in BTU/h indicates the power consumption of the device when it is fully loaded. |
| Optional | Redundancy, Optional Hot Swap PSU |
| Environmental | |
| Operating Temperature | 0–40°C |
| Storage Temperature | -20–60°C |
| Humidity | 0–80% RH, Non-condensing |
| Physical Properties | |
| Housing | Metal |
| Weight | 16.21 kg (35.7 lb) |
| Dimensions (L x W x H) | 48.20 × 46.61 × 17.67 cm (18.98 x 18.35 x 6.96 in.) |
| Rack Height (U Space) | 7U |

VW3620

| Input and Output Boards | |
|--------------------------------|--|
| Board Input | 7 × Slot, up to 32 4K inputs |
| Board Output | 5 × Slot, up to 20 4K outputs |
| Function | 2 x Slots for Function Board, can also used as Input Slot |
| Video Input | |
| Interfaces | Depends on which I/O board is inserted |
| Video Output | |
| Interfaces | Local Output: 1 × HDMI Type A Female (Black) |
| Control | |
| RS-232 | <ul style="list-style-type: none"> ◆ Connector: 1 × DB-9 Female (Black) ◆ Serial Control Pin Configurations: <ul style="list-style-type: none"> ◆ Pin2 = Tx ◆ Pin 3=Rx ◆ Pin 5= Gnd ◆ Baud Rate and Protocol: <ul style="list-style-type: none"> ◆ Baud Rate: 19200 ◆ Data Bits: 8 ◆ Stop Bits: 1 ◆ Parity: No ◆ Flow Control: No |
| Ethernet | Connector: 1 × RJ-45 Female |
| USB | 3 × Keyboard (TBD) / Mouse (TBD) / FW upgrade & Storage |
| EDID Settings | |
| EDID Mode | Default / Port1 / Customized (EDID Wizard support) |
| Communication | |
| Daisy Chain Ports | RJ-45 × 2 |
| Connectors | |
| Power | 1 × 3-Prong AC Socket |

| Power | |
|----------------------------|---|
| Maximum Input Power Rating | 100–240 VAC; 50–60Hz; 10A |
| Consumption | AC110V; 1200W; 2720BTU/h AC220V; 1200W; 2636BTU/h Note: <ul style="list-style-type: none"> ◆ The measurement in Watts indicates the typical power consumption of the device with no external loading. ◆ The measurement in BTU/h indicates the power consumption of the device when it is fully loaded. |
| Optional | Redundancy, Optional Hot Swap PSU |
| Environmental | |
| Operating Temperature | 0–40°C |
| Storage Temperature | -20–60°C |
| Humidity | 0–80% RH, Non-condensing |
| Physical Properties | |
| Housing | Metal |
| Weight | 16.21 kg (35.7 lb) |
| Dimensions (L x W x H) | 48.20 × 45.80 × 30.98 cm (18.98 x 18.03 x 12.2 in.) |
| Rack Height (U Space) | 7U |

VW784 / VW884

| | VW784 | VW884 |
|----------------------------|--|---|
| Video Input | | |
| Interfaces | 4 × HDMI Type A Female (Black) | N/A |
| Impedance | 100 Ω | N/A |
| Max. Distance | Up to 3m | N/A |
| Video Output | | |
| Interfaces | N/A | 4 × HDMI Type A Female (Black) |
| Impedance | N/A | 100 Ω |
| Max. Distance | N/A | Up to 5m |
| Video | | |
| Max. Data Rate | 18.0 Gbps (6 Gbps Per Lane) | 18.0 Gbps (6.0 Gbps Per Lane) |
| Max. Pixel Clock | 600 MHz | 600 MHz |
| Compliance | HDMI (3D, Deep Color, 4K) HDCP 2.2 Compatible Consumer Electronics Control (CEC) | |
| Max. Resolution | 4096 × 2160 / 3840 × 2160 @60Hz (4:4:4) | 4096 × 2160 / 3840 × 2160 @60Hz (4:4:4) |
| Power Consumption | 17.71W; 83BTU/h | 54.72W; 257BTU/h |
| | Note: <ul style="list-style-type: none"> ◆ The measurement in Watts indicates the typical power consumption of the device with no external loading. ◆ The measurement in BTU/h indicates the power consumption of the device when it is fully loaded. | |
| Environmental | | |
| Operating Temperature | 0–40°C | |
| Storage Temperature | -20–60°C | |
| Humidity | 0–80% RH, Non-Condensing | |
| Physical Properties | | |
| Housing | Metal | |
| Weight | 0.73 kg (1.61 lb) | 0.92 kg (2.03 lb) |
| Dimensions (L x W x H) | 19.30 × 27.10 × 2.74 cm (7.6 × 10.67 × 1.08 in.) | 19.30 × 27.10 × 2.74 cm (7.6 × 10.67 × 1.08 in.) |

VW754

| Video Input | |
|----------------------------|---|
| Interfaces | 1 × RJ-45 (10/100/1000 Mbps) |
| Video Compression | |
| | H.265, H.264 over RTSP, Onvif |
| Video | |
| Max. Data Rate | ≤ 25Mbps |
| Max. Resolution | 3840 × 2160@60Hz (4:2:0) |
| Power Consumption | |
| | DC12V; 26.24W; 123BTU/h |
| | <p>Note:</p> <ul style="list-style-type: none"> ◆ The measurement in Watts indicates the typical power consumption of the device with no external loading. ◆ The measurement in BTU/h indicates the power consumption of the device when it is fully loaded. |
| Environmental | |
| Operating Temperature | 0–40°C |
| Storage Temperature | -20–60°C |
| Humidity | 0–80% RH, Non-Condensing |
| Physical Properties | |
| Housing | Metal |
| Weight | 0.83 kg (1.83 lb) |
| Dimensions (L x W x H) | 19.30 × 27.10 × 2.74 cm (7.6 × 10.67 × 1.08 in.) |

ATEN Warranty Policy

The warranty policy may vary by product category and region of purchase. For details, please visit ATEN's official website, select your purchase counties/regions and then go to the Support Center, or contact your local ATEN sales representative for further assistance.

© Copyright 2024–2026 ATEN® International Co., Ltd.
Released: 2026-03-16

ATEN and the ATEN logo are registered trademarks of ATEN International Co., Ltd. All rights reserved. All other brand names and trademarks are the registered property of their respective owners.