



Simply Better Connections

VP200 / VP201

PresentON® Wireless Dongle
User Manual

Compliance Statements

FEDERAL COMMUNICATIONS COMMISSION INTERFERENCE STATEMENT

This equipment has been tested and found to comply with the limits for a Class A digital device, pursuant to Part 15 of the FCC Rules. These limits are designed to provide reasonable protection against harmful interference when the equipment is operated in a commercial environment. This equipment generates, uses, and can radiate radio frequency energy and, if not installed and used in accordance with the instruction manual, may cause harmful interference to radio communications. Operation of this equipment in a residential area is likely to cause harmful interference in which case the user will be required to correct the interference at his own expense.

The device complies with Part 15 of the FCC Rules. Operation is subject to the following two conditions: (1) this device may not cause harmful interference, and (2) this device must accept any interference received, including interference that may cause undesired operation.

FCC Caution

Any changes or modifications not expressly approved by the party responsible for compliance could void the user's authority to operate this equipment.

Warning

Operation of this equipment in a residential environment could cause radio interference.

Achtung

Der Gebrauch dieses Geräts in Wohnumgebung kann Funkstörungen verursachen.

Suggestion

Shield twisted pair (STP) cables must be used with the unit to ensure compliance with FCC & CE standards.



KCC Statement

유선 제품용 / A 급 기기 (업무용 방송 통신 기기)
이 기기는 업무용 (A 급) 전자파적합기기로서 판매자 또는 사용자는 이
점을 주의하시기 바라며, 가정 외의 지역에서 사용하는 것을 목적으로
합니다.

**Trademark Notice:**

The terms HDMI, HDMI High-Definition Multimedia Interface, HDMI trade dress and the HDMI Logos are trademarks or registered trademarks of HDMI Licensing Administrator, Inc.

RoHS

This product is RoHS compliant.

User Information

Online Registration

Be sure to register your product at our online support center:

International	http://eservice.aten.com
---------------	---

Telephone Support

For telephone support, call this number:

International	886-2-8692-6959
China	86-400-810-0-810
Japan	81-3-5615-5811
Korea	82-2-467-6789
North America	1-888-999-ATEN ext 4988 1-949-428-1111

User Notice

All information, documentation, and specifications contained in this manual are subject to change without prior notification by the manufacturer. The manufacturer makes no representations or warranties, either expressed or implied, with respect to the contents hereof and specifically disclaims any warranties as to merchantability or fitness for any particular purpose. Any of the manufacturer's software described in this manual is sold or licensed *as is*. Should the programs prove defective following their purchase, the buyer (and not the manufacturer, its distributor, or its dealer), assumes the entire cost of all necessary servicing, repair and any incidental or consequential damages resulting from any defect in the software.

The manufacturer of this system is not responsible for any radio and/or TV interference caused by unauthorized modifications to this device. It is the responsibility of the user to correct such interference.

The manufacturer is not responsible for any damage incurred in the operation of this system if the correct operational voltage setting was not selected prior to operation. PLEASE VERIFY THAT THE VOLTAGE SETTING IS CORRECT BEFORE USE.

Product Information

For information about all ATEN products and how they can help you connect without limits, visit ATEN on the Web or contact an ATEN Authorized Reseller. Visit ATEN on the Web for a list of locations and telephone numbers:

International	http://www.aten.com
North America	http://www.aten-usa.com

Package Contents

Check to make sure that all of the components are in working order. If you encounter any problem, please contact your dealer.

VP200

- 1 VP200 PresentON® Wireless Dongle
- 1 user instructions

VP201

- 1 VP201 PresentON® Wireless Dongle
- 1 user instructions

Contents

Compliance Statements	ii
User Information	iv
Product Information	v
Package Contents	vi
Contents	vii
About This Manual	ix
Conventions	x
1. Introduction	
Overview	1
VP200	1
VP201	1
Features	2
VP200	2
Content Sharing	2
VP201	3
Content Sharing and BYOM Video Conferencing	3
2. Hardware Setup	
Hardware Overview	5
VP200	5
VP201	6
Pairing the Dongle to a Presentation Switch	7
Screen Sharing	9
VP200	9
VP201	10
LED Indicator	11
Dongle LED	11
Function Button LED	12
3. Using PresentON® Wireless Dongle Utility	
Overview	13
Setup	13
Prerequisites	13

Installation	13
Configuration	15
Configuring the Presentation Switch for Pairing	17
Auto Detect	18
Manual Input.....	19
Configuring the Dongle.....	20
Dongle Configuration Screen	22
Pairing the Dongle with a Presentation Switch.....	23
Settings	24

Appendix

Safety Instructions	25
General	25
Rack Mounting	27
Technical Support	28
Specifications	29
VP200	29
VP201	31
ATEN Warranty Policy	33

About This Manual

This User Manual is provided information to help you get the most from your VP200 / VP201 PresentON® Wireless Dongle. It covers installation, configuration, and operation. An overview of the manual is provided below.

Chapter 1, Introduction, introduces you to the features and purposes of VP200 / VP201 PresentON® Wireless Dongle.

Chapter 2, Hardware Setup, describes the components and provides step-by-step instructions for installing and setting up your VP200 / VP201 PresentON® Wireless Dongle.

Chapter 3, Using PresentON® Wireless Dongle Utility, describes how to configure and manage the dongle using the utility, including pairing and firmware updates.

Appendix, provides product safety instructions, technical support details, and product specifications.

Note:

- ◆ Read this manual thoroughly and follow the installation and operation procedures carefully to prevent any damage to the unit or any connected devices.
 - ◆ The product may be updated, with features and functions added, improved or removed since the release of this manual. For an up-to-date user manual, visit <http://www.aten.com/global/en>
-

Conventions

This manual uses the following conventions:

Monospaced Indicates text that you should key in.

- [] Indicates keys you should press. For example, [Enter] means to press the **Enter** key. If keys need to be chorded, they appear together in the same bracket with a plus sign between them: [Ctrl+Alt].
- 1. Numbered lists represent procedures with sequential steps.
- ◆ Bullet lists provide information, but do not involve sequential steps.
- > Indicates selecting the option (on a menu or dialog box, for example), that comes next. For example, Start > Run means to open the *Start* menu, and then select *Run*.



Indicates critical information.

Chapter 1

Introduction

Overview

VP200

The VP200 works in conjunction with the VP2020 / VP2021 4K Wireless Presentation Switch to take BYOD to the next level. Plug-and-play allows users to instantly share content from their own USB-C laptops wirelessly, eliminating restrictive cables as well as the installation of any software or driver. Due to the VP200's cross-platform compatibility, participants can host meetings on any operating system. The VP200 does not just help foster greater engagement and collaboration among the organization and the remote team members but also save overall costs.

VP201

The VP201 works in conjunction with the VP2020 / VP2021 4K Wireless Presentation Switch to take BYOD & BYOM to the next level. With just one quick click, users can share screen content from their own USB-C laptops wirelessly, eliminating restrictive cables. USB touchback assures presenters efficient remote control over their PCs from the touchscreen / interactive whiteboard in the room without having to go back and forth. Plus, due to the VP201's universal, cross-platform compatibility, participants can interact directly with content from their USB conference devices, such as microphones, cameras, and speakers, and host meetings on all major operating systems using their preferred video conferencing tools like Microsoft Teams and Zoom.

The VP201 does not just transform traditional meeting spaces into hybrid conference rooms, but also fosters collaboration among the organization and the remote team members.

Features

VP200

- ◆ Plug-and-play for instant, wireless A/V content casting and power supply via a single USB-C port
- ◆ Bring Your Own Device (BYOD) — share content from users' USB-C laptops / mobile devices wirelessly
- ◆ OS-independent — work on Windows / macOS / Linux with no need of software / driver installation
- ◆ Point-to-point wireless transmission via native mirroring when connecting to VP2020 / VP2021

Content Sharing

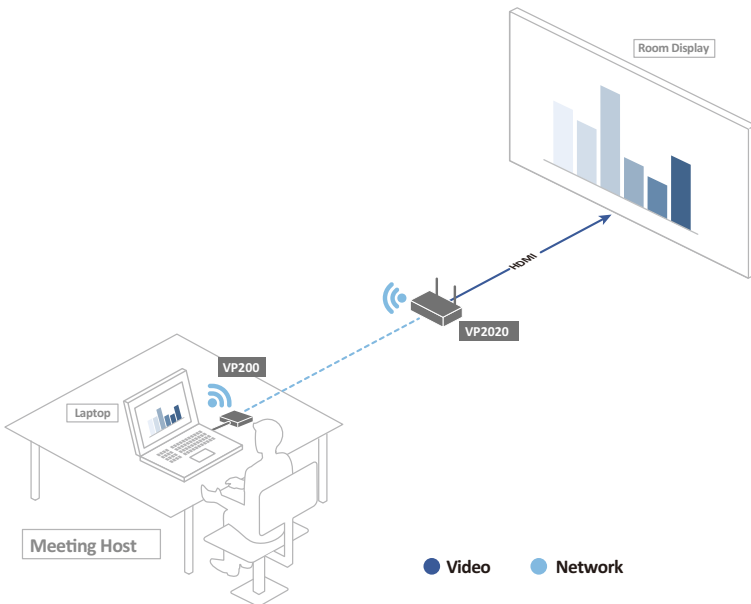

VP201

- ◆ Wireless A/V content casting and power supply via a single USB-C port with just one click
- ◆ USB touchback — enables PC control via the in-room eWhiteboard or content interaction from users' USB devices
- ◆ Bring Your Own Device (BYOD) — share content from users' USB-C laptops / mobile devices wirelessly
- ◆ BYOM (Bring Your Own Meeting) —
 - ◆ Host / Join a video conference using your preferred tool directly from your laptop
 - ◆ Supports video conferencing tools like Microsoft Teams, Google Meet, and Zoom
 - ◆ Supports in-room AV equipment ranging from cameras, microphones to speakers
- ◆ OS-independent — work on Windows / macOS / Linux
- ◆ Point-to-point wireless transmission via native mirroring when connecting to VP2020 / VP2021
- ◆ Plug-and-play with no need to install software / drivers

Content Sharing and BYOM Video Conferencing

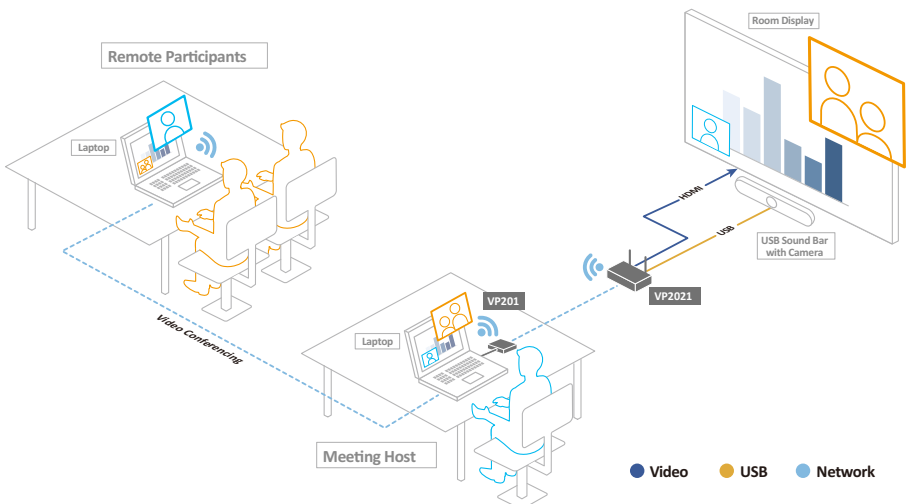

This Page Intentionally Left Blank

Chapter 2

Hardware Setup

Hardware Overview

VP200

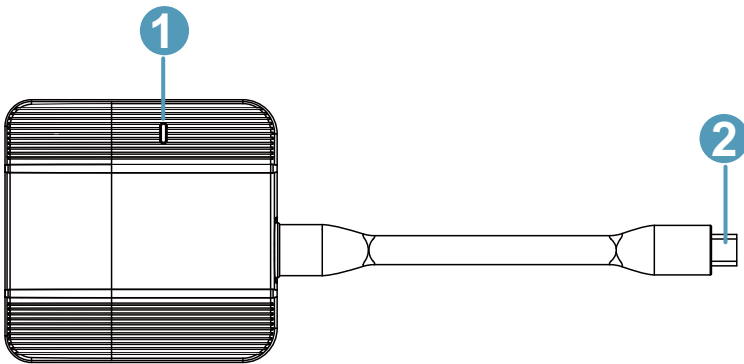

No.	Component	Function
1	dongle LED	Indicates status through LED color changes. Refer to <i>Dongle LED</i> , page 11 for details.
2	USB-C connector	<ul style="list-style-type: none">◆ For setup, connect the dongle to your ATEN 4K Wireless Presentation Switch using the USB-C connector.◆ For screen sharing, connect the dongle to your laptop using the USB-C connector.

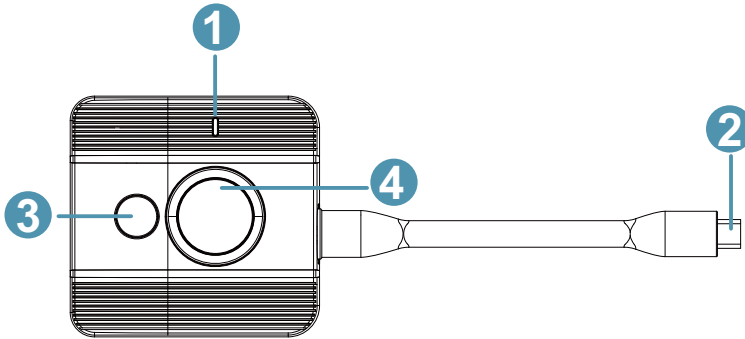
VP201

No.	Component	Function
1	dongle LED	Indicates status through LED color changes. Refer to <i>Dongle LED</i> , page 11 for details.
2	USB-C connector	<ul style="list-style-type: none"> ◆ For setup, connect the dongle to your ATEN 4K Wireless Presentation Switch using the USB-C connector. ◆ For screen sharing, connect the dongle to your laptop using the USB-C connector.
3	function button & function LED	Press the function button to connect the video conferencing device to another laptop. Refer to <i>Function Button LED</i> , page 12 for the function LED information.
4	share button	Short press or long press the share button to control screen sharing.

Pairing the Dongle to a Presentation Switch

To pair your dongle with an ATEN presentation switch:

1. Plug the VP200 / VP201 wireless dongle to the USB-C port of a well-configured, ATEN wireless presentation switch.

Pairing automatically starts.

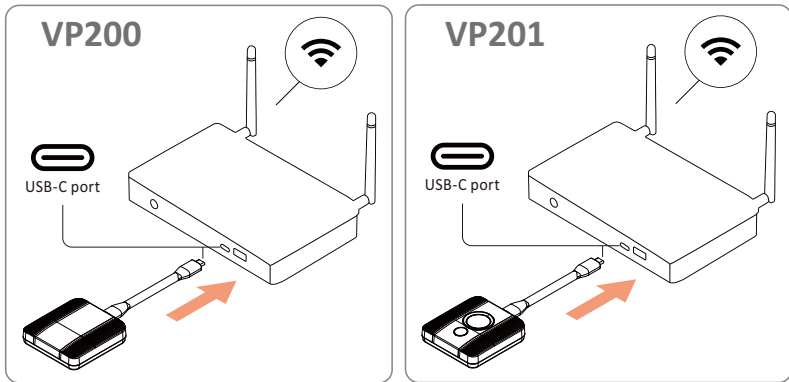

2. The dongle LED indicates the pairing status:

- ◆ **Green, blinking:** Pairing
- ◆ **Green, solid:** Pairing finished

To check the pairing status, view the message on the display monitor connected to the presentation switch.

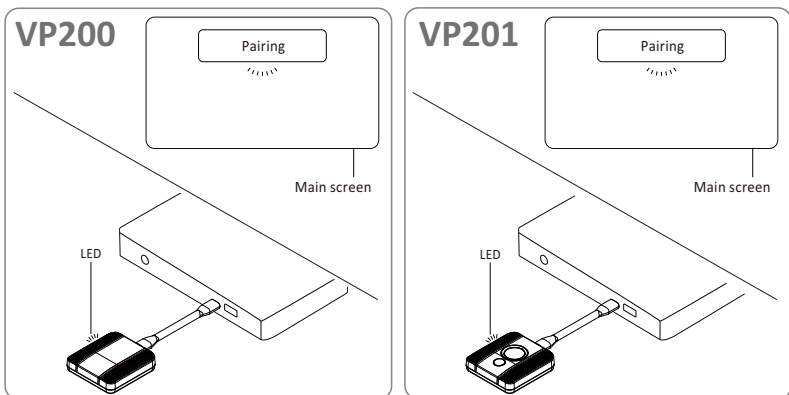

3. When the pairing is finished, unplug the dongle from the presentation switch.

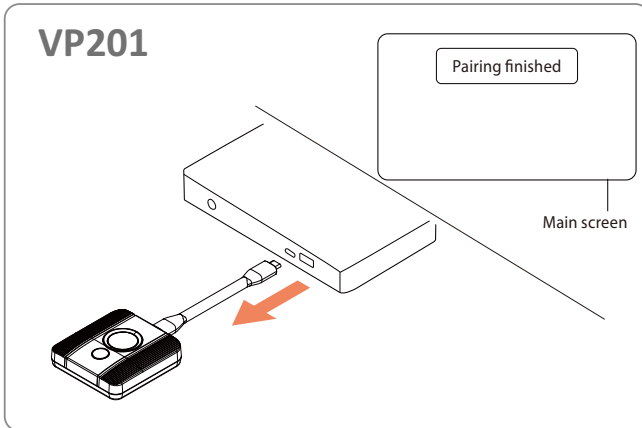
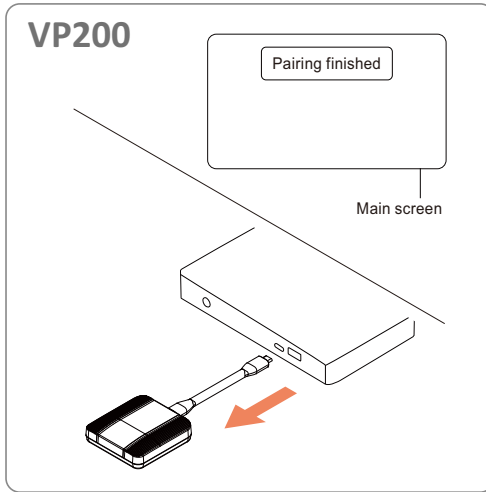

Screen Sharing

The dongle enables instant wireless screen sharing from your laptop after pairing with a presentation switch. Simply connect the dongle to a USB-C port with A/V output to start sharing your screen.

VP200

1. Connect the VP200 dongle to your laptop's USB-C port.

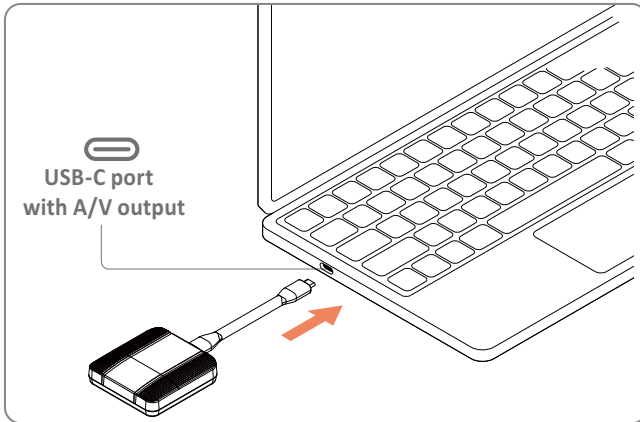

2. Wait until the LED turns solid blue. Your screen will now be shared automatically.

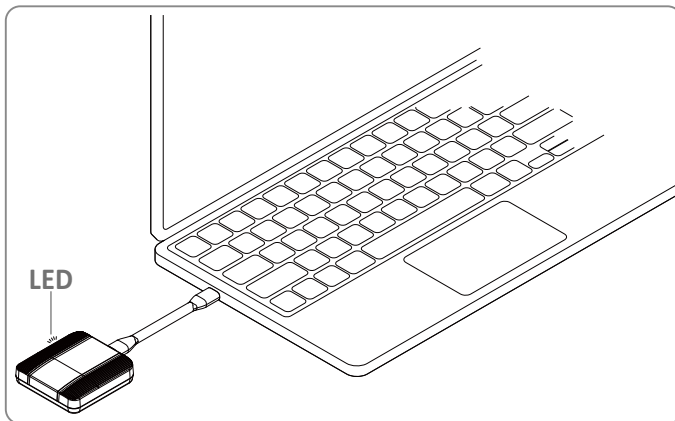

Note: If the LED lights up pink, your device does not support USB-C A/V output.

VP201

1. Connect the dongle to your laptop's USB-C port.
Wait until the LED turns solid blue.

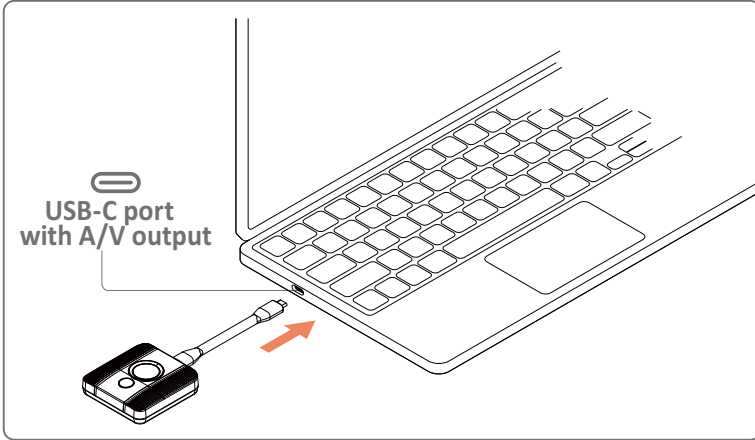

Note: If the LED lights up pink, your device does not support USB-C A/V output.

2. Control sharing by pressing the share button:
 - ◆ **Short press:** Start or stop screen sharing.
 - ◆ **Long press:** Switch between full-screen and split-screen mode.

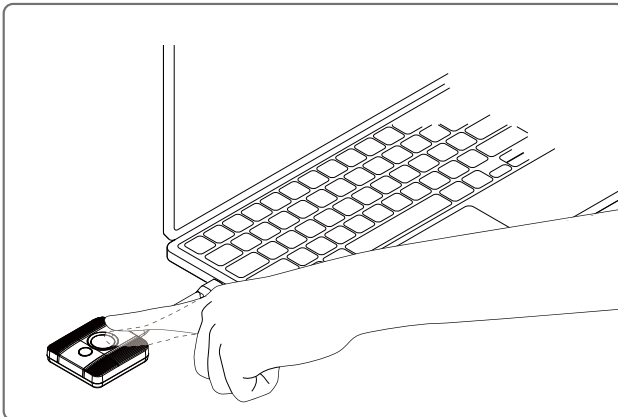

LED Indicator

The LED indicators on the dongle and function button show the device status during pairing, connection, and presentation.

Dongle LED

LED Color	Category	Definition
green, blink	Pairing	Pairing in progress
green, solid	Pairing	Pairing finished
light blue, blink	Presentation	Preparing for presentation
light blue, solid	Presentation	Standby (ready to present)
blue, solid	Presentation	Presenting
blue & red, blink	Firmware	Firmware upgrading
red, solid	Pairing	Pairing failed
	Connection	Wi-Fi connection failed or disconnected. Please pair with the presentation switch again.
amber	Connection	Presentation switch connection failed or disconnected. Please replug the dongle.
pink	Connection	Laptop's USB-C port does not support A/V output.

Function Button LED

The function button LED is available on the VP201 only and is not supported on the VP200.

LED Color	Definition
not lit	No video conferencing device is connected to the presentation switch.
light blue	At least one video conferencing device is connected to the switch.
green	The video conferencing device is wirelessly connected to the laptop.

Chapter 3

Using PresentON® Wireless Dongle Utility

Overview

The PresentON® Wireless Dongle Utility is a Windows-based application used to configure and manage ATEN PresentON® wireless dongles. It provides tools for device setup, firmware updates, and pairing with a presentation switch.

Setup

This section covers the requirements and installation steps for the PresentON® Wireless Dongle Utility.

Prerequisites

Before using the PresentON® Wireless Dongle Utility, make sure you have the following:

- ◆ A PC or laptop with a USB-C port
- ◆ A VP200 / VP201 wireless dongle
- ◆ The IP address of your VP2020 / VP2021 presentation switch

Installation

Follow the steps below to install the utility on your laptop.

1. Go to the VP200 / VP201 product page, open the *Support and Download* tab, and download the utility.

2. Run the .exe file and follow the on-screen instructions to complete the installation.

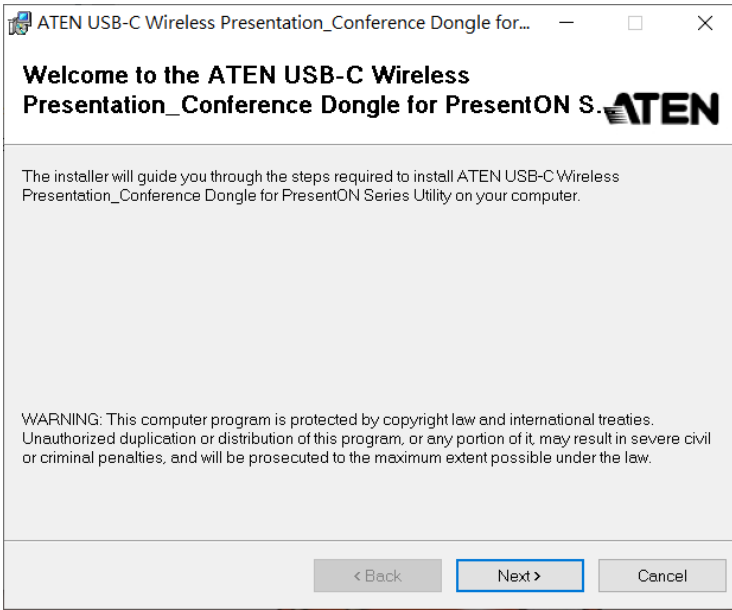

3. After installation, launch the utility.



Configuration

The main screen of the PresentON® Wireless Dongle Utility provides the following functions:



No.	Item	Description
1	presentation switch configuration	Specifies the presentation switch for pairing by entering its IP address. Supports both Auto Detection and Manual Input modes. Refer to <i>Configuring the Presentation Switch for Pairing</i> , page 17 for more information.

No.	Item	Description
2	dongle configuration	<p>Connects your VP200 or VP201 dongle to the laptop for pairing or firmware upgrade.</p> <p>Refer to <i>Configuring the Dongle</i>, page 20 for more information.</p>
3	pairing	<p>After configuring both the presentation switch and the dongle, click the Pair button to pair them.</p> <p>Refer to <i>Pairing the Dongle with a Presentation Switch</i>, page 23 for more information.</p>
4	tips button	<p>Click the Tips button to display information about pairing the dongle with a presentation switch, bidirectional pairing, and the behavior of screen sharing when the dongle is connected to the utility.</p> <div data-bbox="426 676 934 863" style="border: 1px solid #ccc; background-color: #e1f5fe; padding: 10px; margin-top: 10px;"> <p>ⓘ Tips ×</p> <ul style="list-style-type: none"> • This Utility helps you pair the ATEN USB-C Wireless Presentation/Conference Dongle with ATEN 4K Wireless Presentation Switch • Supporting bidirectional pairing. • Once the presentation/conference dongle connects to the utility, the dongle will be forced to stop mirroring. </div>
	settings button	<p>Click the Settings button to open the Settings screen, where you can view the utility version, change the display language, and review the end user license agreement.</p> <p>Refer to <i>Settings</i>, page 24 for more information.</p>

Configuring the Presentation Switch for Pairing

Click **Select** to enter the switch configuration screen. Two methods are available to locate an ATEN 4K wireless presentation switch for pairing.

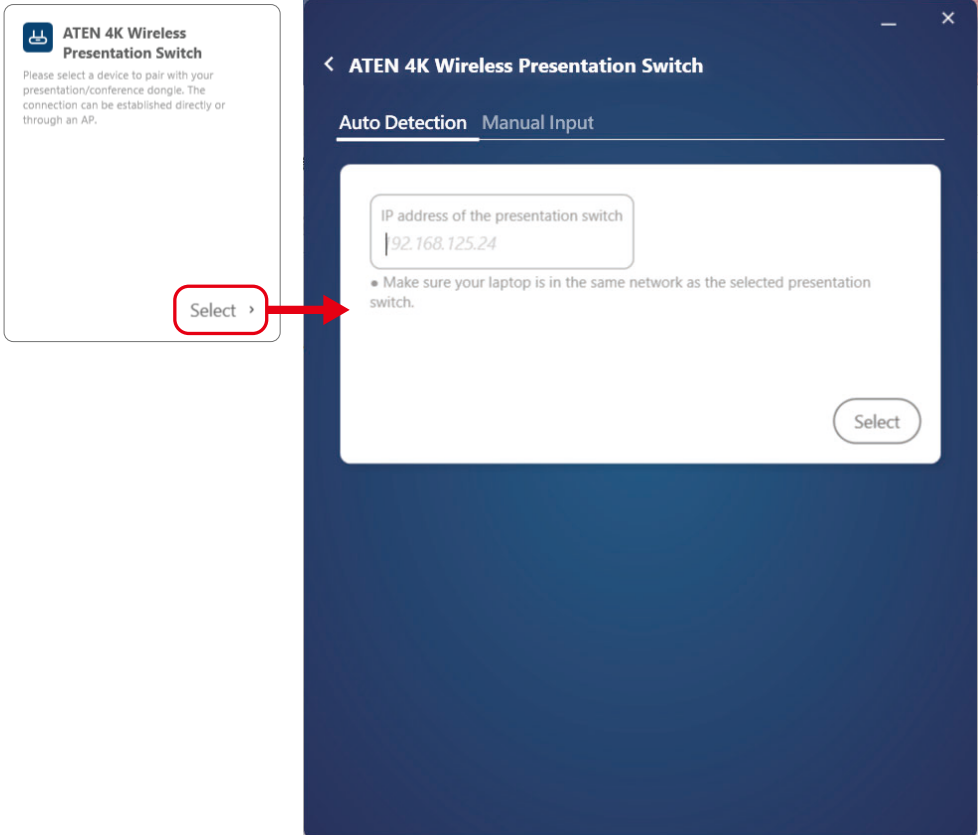

Auto Detect

Use **Auto Detect** to specify a presentation switch using the default pairing method.

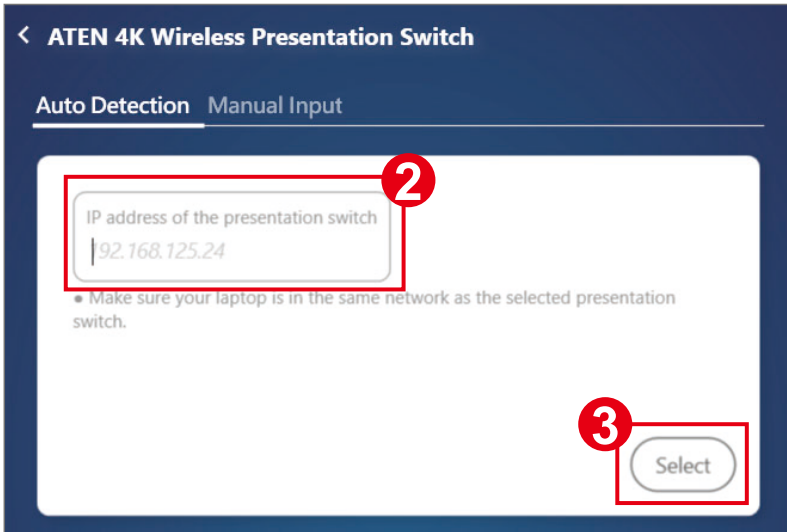

1. Make sure your laptop and the presentation switch are connected to the same network.
2. Enter the IP address of the ATEN 4K wireless presentation switch.
3. Click **Select**.

Manual Input

Use **Manual Input** to specify a wireless access point. This method is not limited to the presentation switch's AP.

The screenshot shows the configuration interface for the ATEN 4K Wireless Presentation Switch. The title bar reads "ATEN 4K Wireless Presentation Switch". Below the title bar, there are two tabs: "Auto Detection" and "Manual Input", with "Manual Input" being the active tab. The main content area contains three input fields and two buttons. The first field is labeled "IP address of the presentation switch" and contains the text "92.168.125.24". The second field is labeled "Device name or wireless AP SSID" and is empty. The third field is labeled "Security Protocol" and has a dropdown menu with "None" selected. The dropdown menu is open, showing the following options: "None", "WPA2", "WPA3", and "WPA3/WPA2 Mixed Mode". At the bottom of the form, there are two buttons: "Clear" and "Save".

1. Enter the IP address of the presentation switch.
2. Enter the presentation switch name (when using the switch's AP), or enter the SSID of another wireless AP on the same LAN.
3. If the AP requires a password, select the security protocol as **WPA2**.
4. Click **Save** to apply the settings.

Configuring the Dongle

To configure your VP200 or VP201 dongle:

1. Plug the dongle into the USB-C port of your laptop.
2. The utility automatically connects to the dongle.



3. Once the connection is established, the dongle configuration section changes to **Details**.

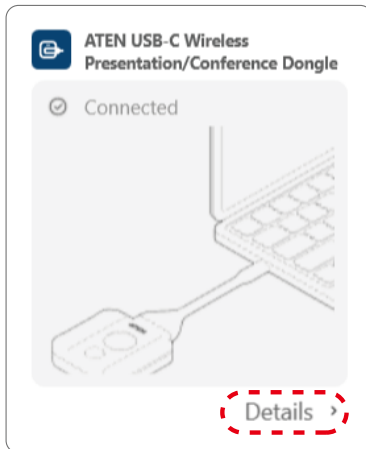

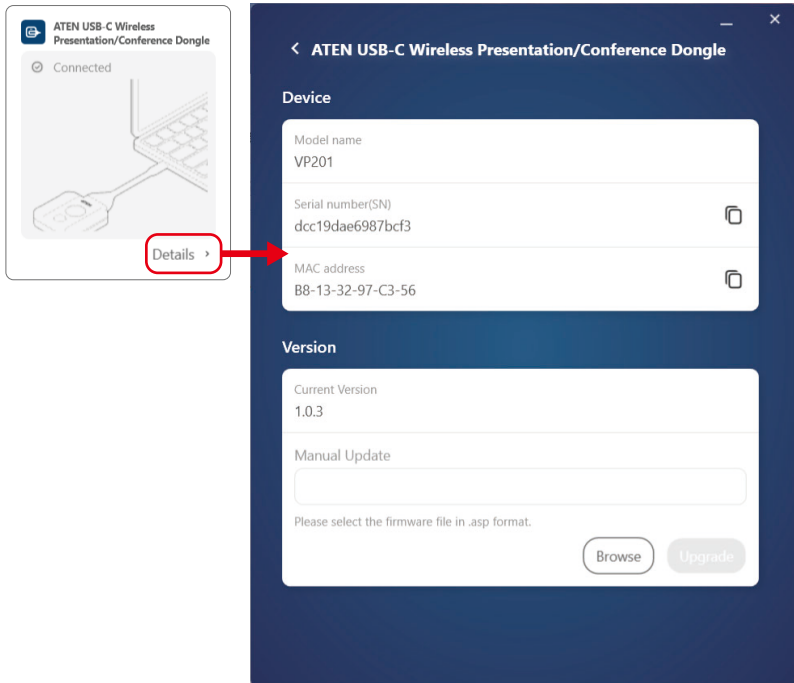

- Click **Details** to open the dongle configuration screen.

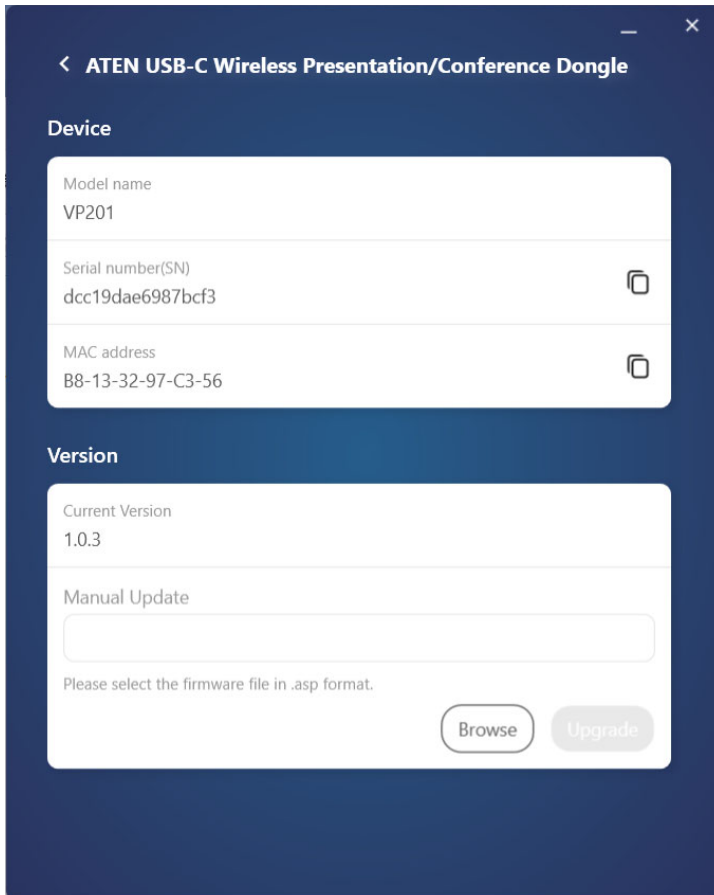

Dongle Configuration Screen

The dongle configuration screen displays the following information and functions:



Item	Description
Device	
Model name	Displays the model name of the connected dongle.
Serial number (SN)	Displays the serial number of the connected dongle. Click the copy button  to copy the serial number.

Item	Description
MAC address	Displays the MAC address of the connected dongle. Click the copy button  to copy the MAC address.
Version	
Current version	Displays the current firmware version of the dongle
Manual update	Click Browse to select a firmware file, then click Upgrade to update the firmware. Note: Firmware downgrade is not supported.

Pairing the Dongle with a Presentation Switch

1. After configuring both the presentation switch and the dongle, click the **Pair** button to start pairing.
2. During pairing, the status is displayed in the utility.
3. Once pairing is complete, the dongle is ready for screen sharing.

Settings

Open the Settings screen to view the utility version, change the display language, and review the end user license agreement.

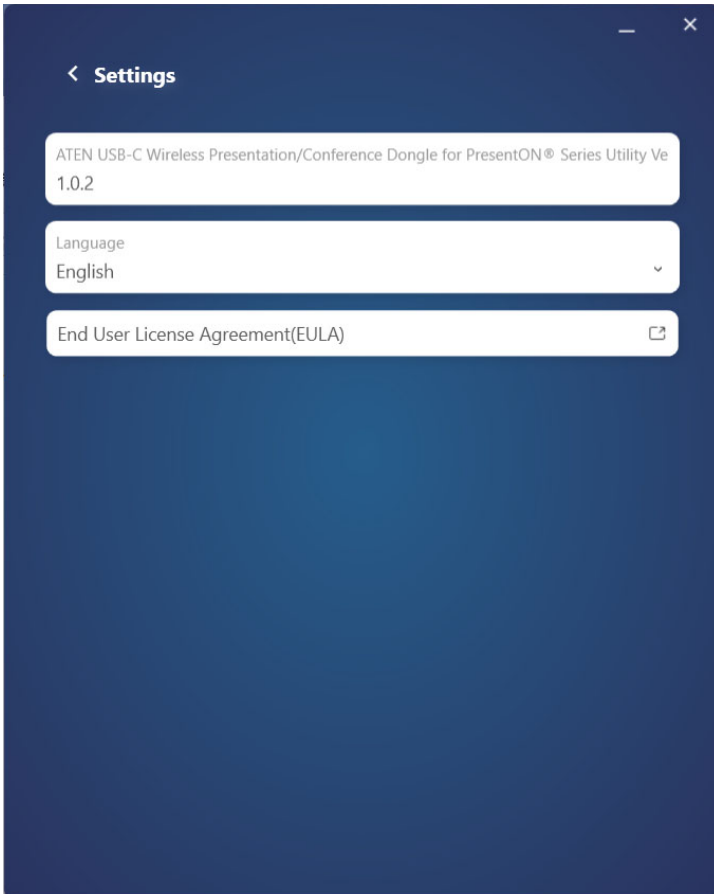

Safety Instructions

General

- ◆ This product is for indoor use only.
- ◆ Read all of these instructions. Save them for future reference.
- ◆ Follow all warnings and instructions marked on the device.
- ◆ Do not place the device on any unstable surface (cart, stand, table, etc.). If the device falls, serious damage will result.
- ◆ Do not use the device near water.
- ◆ Do not place the device near, or over, radiators or heat registers.
- ◆ The device cabinet is provided with slots and openings to allow for adequate ventilation. To ensure reliable operation, and to protect against overheating, these openings must never be blocked or covered.
- ◆ The device should never be placed on a soft surface (bed, sofa, rug, etc.) as this will block its ventilation openings. Likewise, the device should not be placed in a built in enclosure unless adequate ventilation has been provided.
- ◆ Never spill liquid of any kind on the device.
- ◆ Unplug the device from the wall outlet before cleaning. Do not use liquid or aerosol cleaners. Use a damp cloth for cleaning.
- ◆ The device should be operated from the type of power source indicated on the marking label. If you are not sure of the type of power available, consult your dealer or local power company.
- ◆ To prevent damage to your installation it is important that all devices are properly grounded.
- ◆ Do not allow anything to rest on the power cord or cables. Route the power cord and cables so that they cannot be stepped on or tripped over.
- ◆ Position system cables and power cables carefully; Be sure that nothing rests on any cables.
- ◆ Never push objects of any kind into or through cabinet slots. They may touch dangerous voltage points or short out parts resulting in a risk of fire or electrical shock.

- ◆ Do not attempt to service the device yourself. Refer all servicing to qualified service personnel.
- ◆ If the following conditions occur, unplug the device from the wall outlet and bring it to qualified service personnel for repair.
 - ◆ The power cord or plug has become damaged or frayed.
 - ◆ Liquid has been spilled into the device.
 - ◆ The device has been exposed to rain or water.
 - ◆ The device has been dropped, or the cabinet has been damaged.
 - ◆ The device exhibits a distinct change in performance, indicating a need for service.
 - ◆ The device does not operate normally when the operating instructions are followed.
- ◆ Only adjust those controls that are covered in the operating instructions. Improper adjustment of other controls may result in damage that will require extensive work by a qualified technician to repair.

Rack Mounting

- ◆ Before working on the rack, make sure that the stabilizers are secured to the rack, extended to the floor, and that the full weight of the rack rests on the floor. Install front and side stabilizers on a single rack or front stabilizers for joined multiple racks before working on the rack.
- ◆ Always load the rack from the bottom up, and load the heaviest item in the rack first.
- ◆ Make sure that the rack is level and stable before extending a device from the rack.
- ◆ Use caution when pressing the device rail release latches and sliding a device into or out of a rack; the slide rails can pinch your fingers.
- ◆ After a device is inserted into the rack, carefully extend the rail into a locking position, and then slide the device into the rack.
- ◆ Do not overload the AC supply branch circuit that provides power to the rack. The total rack load should not exceed 80 percent of the branch circuit rating.
- ◆ Make sure that all equipment used on the rack – including power strips and other electrical connectors – is properly grounded.
- ◆ Ensure that proper airflow is provided to devices in the rack.
- ◆ Ensure that the operating ambient temperature of the rack environment does not exceed the maximum ambient temperature specified for the equipment by the manufacturer.
- ◆ Do not step on or stand on any device when servicing other devices in a rack.

Technical Support

International

- ◆ For online technical support – including troubleshooting, documentation, and software updates: <http://support.aten.com>
- ◆ For telephone support, see *Telephone Support*, page iv:

North America

Email Support		support@aten-usa.com
Online Technical Support	Troubleshooting Documentation Software Updates	http://www.aten-usa.com/support
Telephone Support		1-888-999-ATEN ext 4988

When you contact us, please have the following information ready beforehand:

- ◆ Product model number, serial number, and date of purchase
- ◆ Your computer configuration, including operating system, revision level, expansion cards, and software
- ◆ Any error messages displayed at the time the error occurred
- ◆ The sequence of operations that led up to the error
- ◆ Any other information you feel may be of help

Specifications

VP200

Function	VP200
Video Input	
Interfaces	1 × USB Type-C
Video	
Max. Data Rate	Average ~ 12Mbps
Max. Resolution	Up to 1080p@60Hz
Wireless	
Authentication Protocol	WPA2-PSK in stand alone mode WPA2-PSK or IEEE 802.1X using the ATEN Present On solution in network integration mode
Wireless Transmission Protocol	IEEE 802.11 a/g/n/ac
Frequency Band	Switchable dual band 2.4GHz and 5GHz (DFS channels not supported)
Reach	Up to 10m (33ft) line of sight from Dongle to Station
Connectors	
Console Ports	1 × USB Type C male
Power	1 × USB Type C male

Function	VP200
Power Consumption	DC5V; 1.37WBTU/h Note: <ul style="list-style-type: none">◆ The measurement in Watts indicates the typical power consumption of the device with no external loading.◆ The measurement in BTU/h indicates the power consumption of the device when it is fully loaded.
Environmental	
Operating Temperature	0°C to 40°C
Storage Temperature	-10°C to 70°C
Humidity	20% to 80% RH, Non-Condensing for Operation
Physical Properties	
Housing	Plastic
Weight	0.09 kg (0.2 lb)
Dimensions (L × W × H)	6.70 × 6.90 × 1.50 cm (2.64 × 2.72 × 0.59 in.)
Carton Lot	30 pcs

VP201

Function	VP201
Video Input	
Interfaces	1 × USB Type-C
Video	
Max. Data Rate	Average ~ 12Mbps
Max. Resolution	Up to 1080p@60Hz
Wireless	
Authentication Protocol	WPA2-PSK in stand alone mode WPA2-PSK or IEEE 802.1X using the ATEN Present On solution in network integration mode
Wireless Transmission Protocol	IEEE 802.11 a/g/n/ac
Frequency Band	Switchable dual band 2.4GHz and 5GHz (DFS channels not supported)
Reach	Up to 10m (33ft) line of sight from Dongle to Station
Connectors	
Console Ports	1 × USB Type C male
Power	1 × USB Type C male
Pushbuttons	
Operating Mode Selection	1 × Video Sharing ON/OFF 1 × USB Conference ON/OFF
LEDs	
LED Indicator	1 × Video Sharing status LED 1 × Conference Status LED

Function	VP201
Power Consumption	DC5V; 1.37WBTU/h Note: <ul style="list-style-type: none">◆ The measurement in Watts indicates the typical power consumption of the device with no external loading.◆ The measurement in BTU/h indicates the power consumption of the device when it is fully loaded.
Environmental	
Operating Temperature	0°C to 40°C
Storage Temperature	-10°C to 70°C
Humidity	20% to 80% RH, Non-Condensing for Operation
Physical Properties	
Housing	Plastic
Weight	0.09 kg (0.2 lb)
Dimensions (L × W × H)	6.70 × 6.90 × 1.50 cm (2.64 × 2.72 × 0.59 in.)
Carton Lot	30 pcs

ATEN Warranty Policy

The warranty policy may vary by product category and region of purchase. For details, please visit ATEN's official website, select your purchase countries/ regions and then go to the Support Center, or contact your local ATEN sales representative for further assistance.

© Copyright 2026 ATEN® International Co., Ltd.
Released: 2026-04-17

ATEN and the ATEN logo are registered trademarks of ATEN International Co., Ltd. All rights reserved. All other brand names and trademarks are the registered property of their respective owners.