



**USB 2.0 DVI KVM Extender
CE610**

User Manual



EMC Information

FEDERAL COMMUNICATIONS COMMISSION INTERFERENCE STATEMENT: This equipment has been tested and found to comply with the limits for a Class A digital device, pursuant to Part 15 of the FCC Rules. These limits are designed to provide reasonable protection against harmful interference when the equipment is operated in a commercial environment. This equipment generates, uses, and can radiate radio frequency energy and, if not installed and used in accordance with the instruction manual, may cause harmful interference to radio communications. Operation of this equipment in a residential area is likely to cause harmful interference in which case the user will be required to correct the interference at his own expense.

The device complies with Part 15 of the FCC Rules. Operation is subject to the following two conditions: (1) this device may not cause harmful interference, and (2) this device must accept any interference received, including interference that may cause undesired operation.

FCC Caution: Any changes or modifications not expressly approved by the party responsible for compliance could void the user's authority to operate this equipment.

CE Warning: This is a class A product. In a domestic environment this product may cause radio interference in which case the user may be required to take adequate measures.

Suggestion: Shielded twisted pair (STP) cables must be used with the unit to ensure compliance with FCC & CE standards.

KCC Statement

유선 제품용 / A 급 기기 (업무용 방송 통신 기기)
이 기기는 업무용 (A 급) 전자파적합기기로서 판매자 또는 사용자는 이 점을 주의하시기 바라며 , 가정 외의 지역에서 사용하는 것을 목적으로 합니다 .

RoHS

This product is RoHS compliant.



SJ/T 11364-2006

The following contains information that relates to China.

部件名称	有毒有害物质或元素					
	铅	汞	镉	六价铬	多溴联苯	多溴二苯醚
电器部件	●	○	○	○	○	○
机构部件	○	○	○	○	○	○

- : 表示该有毒有害物质在该部件所有均质材料中的含量均在SJ/T 11363-2006规定的限量要求之下。
- : 表示符合欧盟的豁免条款，但该有毒有害物质至少在该部件的某一均质材料中的含量超出SJ/T 11363-2006的限量要求。
- ×: 表示该有毒有害物质至少在该部件的某一均质材料中的含量超出SJ/T 11363-2006的限量要求。

User Information

Online Registration

Be sure to register your product at our online support center:

International	http://eservice.aten.com
---------------	---

Telephone Support

For telephone support, call this number:

International	886-2-8692-6959
China	86-10-5255-0110
Japan	81-3-5615-5811
Korea	82-2-467-6789
North America	1-888-999-ATEN ext 4988
United Kingdom	44-8-4481-58923

User Notice

All information, documentation, and specifications contained in this manual are subject to change without prior notification by the manufacturer. The manufacturer makes no representations or warranties, either expressed or implied, with respect to the contents hereof and specifically disclaims any warranties as to merchantability or fitness for any particular purpose. Any of the manufacturer's software described in this manual is sold or licensed *as is*. Should the programs prove defective following their purchase, the buyer (and not the manufacturer, its distributor, or its dealer), assumes the entire cost of all necessary servicing, repair and any incidental or consequential damages resulting from any defect in the software.

The manufacturer of this system is not responsible for any radio and/or TV interference caused by unauthorized modifications to this device. It is the responsibility of the user to correct such interference.

The manufacturer is not responsible for any damage incurred in the operation of this system if the correct operational voltage setting was not selected prior to operation. **PLEASE VERIFY THAT THE VOLTAGE SETTING IS CORRECT BEFORE USE.**

Package Contents

The CE610 package consists of:

- ◆ 1 CE610L USB 2.0 DVI KVM Extender (Local Unit)
- ◆ 1 CE610R USB 2.0 DVI KVM Extender (Remote Unit)
- ◆ 1 Custom DVI 1.8 m Cable
- ◆ 1 1.8 m USB Cable
- ◆ 2 Power Adapters
- ◆ 1 Mounting Kit
- ◆ 1 User Instructions*

Check to make sure that all the components are present and that nothing got damaged in shipping. If you encounter a problem, contact your dealer.

Read this manual thoroughly and follow the installation and operation procedures carefully to prevent any damage to the unit, and/or any of the devices connected to it.

* Features may have been added to the CE610 since this manual was published. Please visit our website to download the most up-to-date version of the manual.

© Copyright 2015 ATEN® International Co., Ltd.
Manual Date: 2015-11-02

ATEN and the ATEN logo are registered trademarks of ATEN International Co., Ltd. All rights reserved.
All other brand names and trademarks are the registered property of their respective owners.

Contents

EMC Information	ii
RoHS	ii
SJ/T 11364-2006	iii
User Information	iv
Online Registration	iv
Telephone Support	iv
User Notice	iv
Package Contents	v
About this Manual	vii
Conventions	viii
Product Information	viii

Chapter 1.

Introduction

Overview	1
Features	2
Requirements	3
Consoles	3
Computers	3
Cables	3
Operating Systems	4
Components	5
CE610L (Local Unit) Front and Rear View	5
CE610R (Remote Unit) Front and Rear View	6

Chapter 2.

Hardware Setup

Rack Mounting	7
Installation	9
Grounding	9
Setting Up	11
Installation Diagram	12

Chapter 3.

Operation

LED Display	13
CE610L (Local Unit) and CE610R (Remote Unit)	13

Appendix

Safety Instructions	14
General	14
Mounting	16
Technical Support	17
International	17
North America	17

Specifications 18
Limited Warranty..... 19

About this Manual

This User Manual is provided to help you get the most from your system. It covers all aspects of installation, configuration and operation. An overview of the information found in the manual is provided below.

Chapter 1, Introduction, introduces you to the CE610 system. Its purpose, features and benefits are presented, and its front and back panel components are described.

Chapter 2, Hardware Setup, describes the steps that are necessary to quickly and safely set up your installation.

Chapter 3, Operation, explains the fundamental concepts involved in operating the CE610

An Appendix, provides specifications and other technical information regarding the CE610.

Conventions

This manual uses the following conventions:

- Monospaced Indicates text that you should key in.
- [] Indicates keys you should press. For example, [Enter] means to press the **Enter** key. If keys need to be chorded, they appear together in the same bracket with a plus sign between them: [Ctrl+Alt].
- 1. Numbered lists represent procedures with sequential steps.
- ◆ Bullet lists provide information, but do not involve sequential steps.
- Indicates selecting the option (on a menu or dialog box, for example), that comes next. For example, Start → Run means to open the *Start* menu, and then select *Run*.
-  Indicates critical information.

Product Information

For information about all ATEN products and how they can help you connect without limits, visit ATEN on the Web or contact an ATEN Authorized Reseller. Visit ATEN on the Web for a list of locations and telephone numbers:

International	http://www.aten.com
North America	http://www.aten-usa.com

Chapter 1

Introduction

Overview

The CE610 USB 2.0 DVI KVM Extender is a DVI and USB Extender that supports ExtremeUSB® and HDBaseT technology. The CE610 USB 2.0 DVI KVM Extender can extend DVI and USB 2.0 signals up to 300 ft (100 m) from the source using a single Cat 5e/6 cable. The CE610 is equipped with USB connectors which allow you to extend any USB device between the units. The USB functionality provides not only peripheral sharing but also provides support for touch panel control and file transfer. The CE610 is ideal for transportation centers, medical facilities, and shopping malls, industrial kiosks and for syncing files and folders between portable and desktop computers.

The CE610 allows access to a computer system from a remote console (USB keyboard, monitor, and mouse). Because it allows access to a computer system from a remote console, the CE610 is perfect for use in any type of installation where you need to place the console where it is conveniently accessible, but you want the system equipment to reside in a safe location – away from the dust and dirt of the factory floor, or the harsh environmental influence of a construction site, for example. This allows users to deploy system equipment over large distances.

The CE610 is useful for control and security purposes, where you can have the system unit in a secure area at the same time that you put the console in the most convenient location for user access. This is ideal for managing highly confidential data systems.

The CE610 improves on previous designs by: 1) using inexpensive Cat 5e cable instead of bulkier, more expensive, standard DVI cables, for a much neater, more convenient, more reliable data transfer connection; and 2) featuring a custom ASIC to ensure the utmost in reliability and compatibility.

Setup is as easy as can be – simply connect the computer system box; run the Cat 5e cable up to 100 meters to the Remote Unit; and plug the remote console into the Remote Unit.

Features

- ◆ Uses a single Cat 5e cable to connect the local and remote units
- ◆ Allows access to a computer or KVM installation from a remote console
- ◆ Superior Video Quality – up to 1920 x 1200 @ 60 Hz at 100 m
- ◆ Supports HDBaseT connectivity technology
- ◆ Transparent USB Support – supports all USB 2.0 High Speed device*
- ◆ Extends local PC Video/Keyboard/Mouse to Remote side
- ◆ Built-in 8KV/15KV ESD protection (Contact voltage 8KV; Air voltage 15KV)
- ◆ ExtremeUSB® - supports transparent USB 2.0 signals and true plug-and-play (no software or drivers required)
- ◆ USB 2.0 Support* – connects devices such as keyboard, mouse, flash drive, printer, touch panel, USB 1.1 web cameras and other USB devices which require moderate amounts of bandwidth
- ◆ Works with all major operating systems: Windows®, OS X®, and Linux®

***Note:** The CE610 supports a maximum combined USB transfer rate of 30 Mbps for attached USB devices.

Requirements

Consoles

- ♦ A DVI-D monitor capable of the highest resolution you will be using on any computer in the installation.
- ♦ A USB keyboard
- ♦ A USB mouse

Computers

The following equipment must be installed on each computer that is to be connected to the system:

- ♦ A DVI-D / DVI-I port
- ♦ 2 USB ports for the mouse and keyboard
- ♦ Microphone and speaker ports (optional)

Cables

- ♦ For optimal signal integrity, and to simplify the layout, we strongly recommend that you use the high quality custom DVI Cable that is provided with this package.
- ♦ Cat 5e cable is required to connect the Local and Remote CE610 Units. Cable of a lower standard will result in degrading of the video signal. We strongly recommend using Cat 5e cables.
- ♦ For better quality over longer distances, we suggest using 2L-2801 (350 MHz) Low Skew Cable

Maximum Cable Distances

Connection	Distance
Computer to Local Unit (CE610L)	1.8 m
Local Unit (CE610L) to Remote Unit (CE610R)	100 m
Remote Unit (CE610R) to monitor	5 m

Operating Systems

Supported operating systems are shown in the table, below:

OS		Version
Windows		2000 and higher
Linux	RedHat	9.0 and higher
	SuSE	10 / 11.1 and higher
	Debian	3.1 / 4.0
	Ubuntu	7.04 / 7.10
UNIX	FreeBSD	5.5 / 6.1 / 6.2
Novell	Netware	6.0 and higher
Mac		OS 10.1 and higher

Note: The CE610 does not support OS that do not support USB.

Components

CE610L (Local Unit) Front and Rear View

Front View

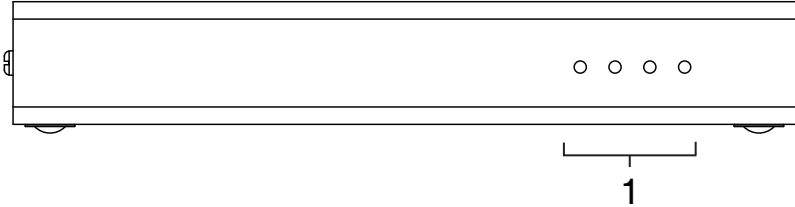

Rear View

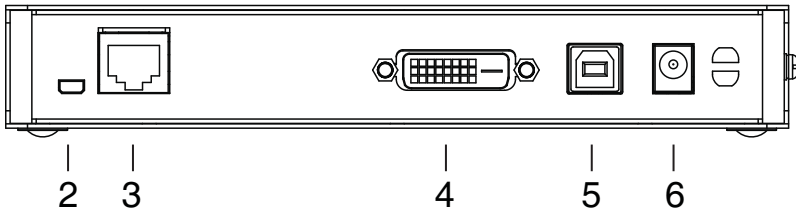

No.	Component	Description
1	LEDs	The CE610L has four LEDs to indicate operating status – Power, Link, USB, and Video.
2	Firmware Upgrade Port	The Firmware Upgrade Port is reserved for technical support. If you would like to upgrade the unit's firmware yourself, please contact your ATEN dealer.
3	Unit to Unit Port	The Cat 5e cable that connects the Local and Remote Units plugs in here.
4	DVI-D In Port	Connect a DVI cable from a computer to this port.
5	USB Type B Input	The USB cable from your computer or USB hub plugs in here.
6	Power Jack	The cable from the Power adapter connects here.

CE610R (Remote Unit) Front and Rear View

Front View

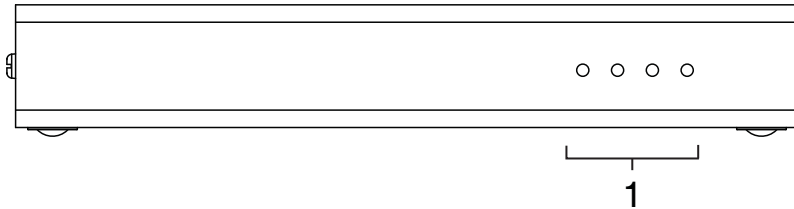

Rear View

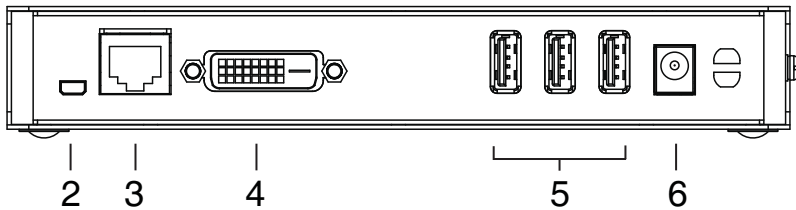

No.	Component	Description
1	LEDs	The CE610R has four LEDs to indicate operating status – Power, Link, USB, and Video.
2	Firmware Upgrade Port	The Firmware Upgrade Port is reserved for technical support. If you would like to upgrade the unit's firmware yourself, please contact your ATEN dealer.
3	Unit to Unit Port	The Cat 5e cable that connects the Local and Remote Units plugs in here.
4	DVI-D Out Port	Connect a DVI monitor to this port.
5	USB Type A Ports	Your USB 2.0 devices plug in here.
6	Power Jack	The cable from the Power adapter connects here.

Chapter 2

Hardware Setup



1. Important safety information regarding the placement of this device is provided on page 14. Please review it before proceeding.
2. Make sure that the power to all devices connected to the installation are turned off. You must unplug the power cords of any computers that have the Keyboard Power On function.

Rack Mounting

For convenience and flexibility, the CE610 can be mounted on system racks. To rack mount a unit do the following:

1. Using the screws provided in the Mounting Kit, screw the mounting bracket into the top or bottom of the unit as show in the diagram below:

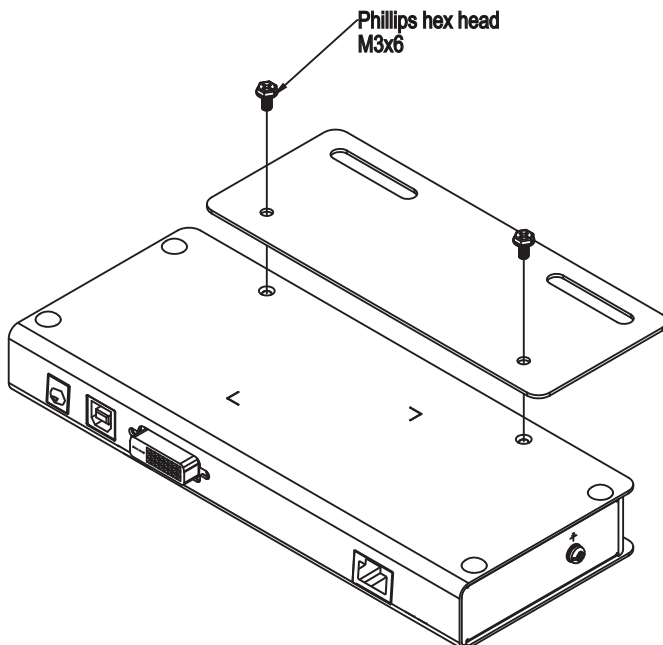

2. Screw the bracket into any convenient location on the rack.

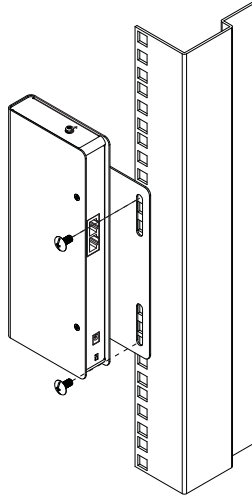
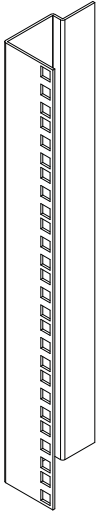

Note: These screws are not provided. We recommend that you use M5 x 12 Phillips Type I cross, recessed type screws.

Installation

Grounding

To prevent damage to your installation it is important that all devices are properly grounded.

1. Use a grounding wire to ground both units by connecting one end of the wire to the grounding terminal, and the other end of the wire to a suitable grounded object.

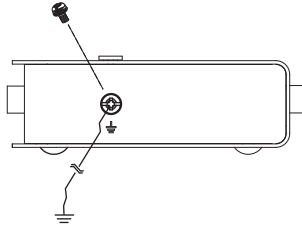

2. Make sure that the computer that the Local Unit connects to and the monitor that the Remote Unit connects to are properly grounded.

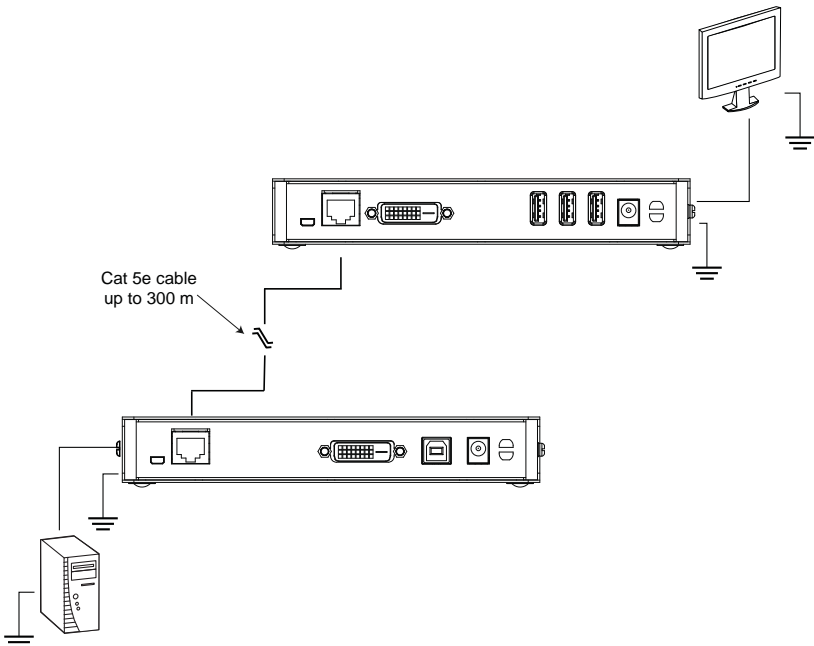

3. For increased grounding protection, use STP (shielded twisted pair) cable to connect the Local and Remote Units. There are two methods that can be used:

a) In addition to the eight paired wires, STP cable also contains a grounding wire. Solder this wire to the RJ-45 connector as shown in the diagram below:

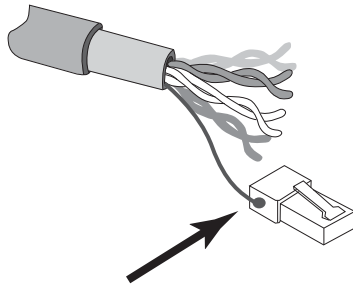

b) The second method is to use the STP cable shielding for grounding. In this case, make sure that the shielding makes tight contact with the top inside of the RJ-45 connector as shown in the diagram below:

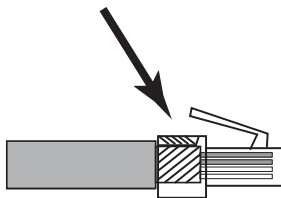

In either case, make sure that the sides of the RJ-45 connector make tight contact with the grounding contacts on the sides of the RJ-45 socket as shown in the diagram below:

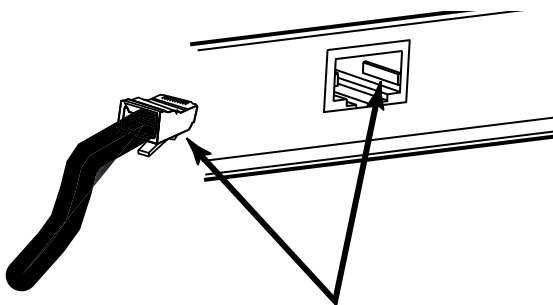

Setting Up

Setting up the CE610 DVI KVM Extender system is simply a matter of plugging in the cables. Make sure that all the equipment to be connected are powered off. Refer to the installation diagram on the following page and do the following:

1. Connect the USB cable supplied with the package to the **USB Type B port** on the Local Unit (CE610L). Plug the other end of the cable into a USB Type A port on the local computer.
2. Connect the DVI-D cable supplied with the package to the **DVI-D input port** located on the Local Unit (CE610L). Plug the other end of the cable into the DVI port on the local computer.
3. Plug either end of the Cat 5e cable into the CE610's Unit to Unit **R-J45 port**. Plug the other end of the Cat 5e cable into the Unit to Unit **RJ-45 port** of the Remote Unit (CE610R).
4. Plug one of the power adapters (supplied with this package) into a power source; plug the adapter's power cable into the CE610L's **Power Jack**.
5. Use a DVI cable to connect the **DVI-D output port** on the Remote Unit (CE610R) to your monitor.
6. Plug the cables from the remote USB devices (mouse, keyboard, etc.), into their respective **USB ports** on the Remote Unit CE610R.
7. Plug the second power adapter (supplied with this package) into a power source; plug the adapter's power cable into the CE610R's **Power Jack**.

Installation Diagram

CE610L Rear View

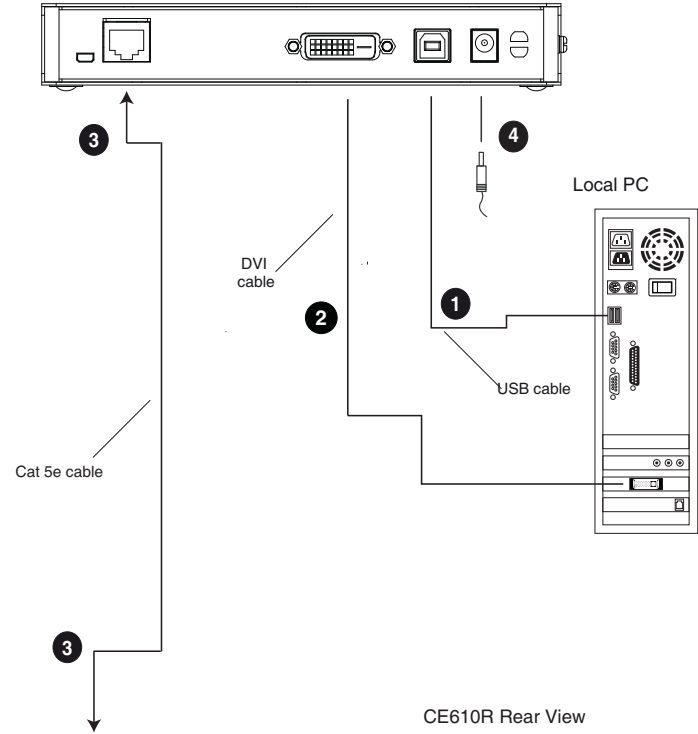

CE610R Rear View

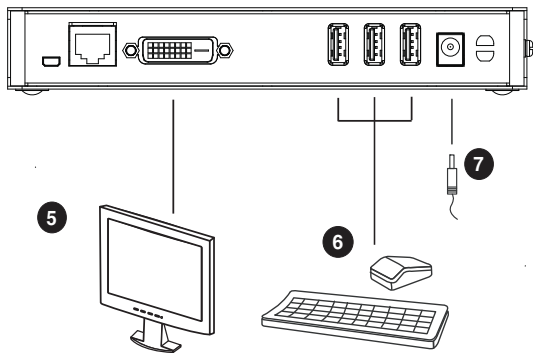

Chapter 3

Operation

LED Display

The CE610 Local and Remote Units have front panel LEDs to indicate their operating status, as shown in the tables, following:

CE610L (Local Unit) and CE610R (Remote Unit)

LED	Indication
Power (Green)	Lights steadily to indicate that the system is receiving power.
Link (Green)	<ul style="list-style-type: none">◆ Lights steadily to indicate that the connection to the Local and Remote units is ok.◆ OFF when there is a problem with the connection.
USB (Green)	<ul style="list-style-type: none">◆ Lights to indicate that the USB connection to the host computer is working.◆ Flashes green to indicate that the host is in suspend mode.◆ OFF indicates that the link is inactive.
Video (Green)	<ul style="list-style-type: none">◆ Flashes to indicate normal video activity.◆ Lights steadily to indicate HDCP video activity.◆ OFF indicates that there is no video activity.

Safety Instructions

General

- ◆ Read all of these instructions. Save them for future reference.
- ◆ Follow all warnings and instructions marked on the device.
- ◆ This product is for indoor use only.
- ◆ Do not place the device on any unstable surface (cart, stand, table, etc.). If the device falls, serious damage will result.
- ◆ Do not use the device near water.
- ◆ Do not place the device near, or over, radiators or heat registers.
- ◆ The device cabinet is provided with slots and openings to allow for adequate ventilation. To ensure reliable operation, and to protect against overheating, these openings must never be blocked or covered.
- ◆ The device should never be placed on a soft surface (bed, sofa, rug, etc.) as this will block its ventilation openings. Likewise, the device should not be placed in a built in enclosure unless adequate ventilation has been provided.
- ◆ Never spill liquid of any kind on the device.
- ◆ Unplug the device from the wall outlet before cleaning. Do not use liquid or aerosol cleaners. Use a damp cloth for cleaning.
- ◆ The device should be operated from the type of power source indicated on the marking label. If you are not sure of the type of power available, consult your dealer or local power company.
- ◆ The device is designed for IT power distribution systems with 230V phase-to-phase voltage.
- ◆ To prevent damage to your installation, it is important that all devices are properly grounded.
- ◆ The device is equipped with a 3-wire grounding type plug. This is a safety feature. If you are unable to insert the plug into the outlet, contact your electrician to replace your obsolete outlet. Do not attempt to defeat the purpose of the grounding-type plug. Always follow your local/national wiring codes.
- ◆ Do not allow anything to rest on the power cord or cables. Route the power cord and cables so that they cannot be stepped on or tripped over.

- ◆ If an extension cord is used with this device make sure that the total of the ampere ratings of all products used on this cord does not exceed the extension cord ampere rating. Make sure that the total of all products plugged into the wall outlet does not exceed 15 amperes.
- ◆ To help protect your system from sudden, transient increases and decreases in electrical power, use a surge suppressor, line conditioner, or un-interruptible power supply (UPS).
- ◆ Position system cables and power cables carefully; Be sure that nothing rests on any cables.
- ◆ Never push objects of any kind into or through cabinet slots. They may touch dangerous voltage points or short out parts resulting in a risk of fire or electrical shock.
- ◆ Do not attempt to service the device yourself. Refer all servicing to qualified service personnel.
- ◆ If the following conditions occur, unplug the device from the wall outlet and bring it to qualified service personnel for repair.
 - ◆ The power cord or plug has become damaged or frayed.
 - ◆ Liquid has been spilled into the device.
 - ◆ The device has been exposed to rain or water.
 - ◆ The device has been dropped, or the cabinet has been damaged.
 - ◆ The device exhibits a distinct change in performance, indicating a need for service.
 - ◆ The device does not operate normally when the operating instructions are followed.
- ◆ Only adjust those controls that are covered in the operating instructions. Improper adjustment of other controls may result in damage that will require extensive work by a qualified technician to repair.

Mounting

- ◆ Before working on the rack, make sure that the stabilizers are secured to the rack, extended to the floor, and that the full weight of the rack rests on the floor. Install front and side stabilizers on a single rack or front stabilizers for joined multiple racks before working on the rack.
- ◆ Always load the rack from the bottom up, and load the heaviest item in the rack first.
- ◆ Make sure that the rack is level and stable before extending a device from the rack.
- ◆ Use caution when pressing the device rail release latches and sliding a device into or out of a rack; the slide rails can pinch your fingers.
- ◆ After a device is inserted into the rack, carefully extend the rail into a locking position, and then slide the device into the rack.
- ◆ Do not overload the AC supply branch circuit that provides power to the rack. The total rack load should not exceed 80 percent of the branch circuit rating.
- ◆ Make sure that all equipment used on the rack – including power strips and other electrical connectors – is properly grounded.
- ◆ Ensure that proper airflow is provided to devices in the rack.
- ◆ Ensure that the operating ambient temperature of the rack environment does not exceed the maximum ambient temperature specified for the equipment by the manufacturer.
- ◆ Do not step on or stand on any device when servicing other devices in a rack.

Technical Support

International

- ◆ For online technical support – including troubleshooting, documentation, and software updates: **<http://eservice.aten.com>**
- ◆ For telephone support, *Telephone Support*, page iv

North America

Email Support		support@aten-usa.com
Online Technical Support	Troubleshooting Documentation Software Updates	http://www.aten-usa.com/support
Telephone Support		1-888-999-ATEN ext 4988

When you contact us, please have the following information ready beforehand:

- ◆ Product model number, serial number, and date of purchase.
- ◆ Your computer configuration, including operating system, revision level, expansion cards, and software.
- ◆ Any error messages displayed at the time the error occurred.
- ◆ The sequence of operations that led up to the error.
- ◆ Any other information you feel may be of help.

Specifications

Function		CE610L	CE610R
Connectors	DVI In	1 x DVI-D Female (White)	N/A
	DVI Out	N/A	1 x DVI-D Female (White)
	USB	1 x USB Type B Female (White)	3 x USB Type A Female (White)
	Power	1 x DC Jack	
	F/W Upgrade	1 x Mini-USB	
	Unit to Unit	1 x RJ-45 Female (Black)	
LEDs	Power	1 (Green)	1 (Green)
	Link	1 (Green)	1 (Green)
	USB	1 (Green)	1 (Green)
	Video	1 (Green)	1 (Green)
USB	Transfer Rate	USB 2.0 (Up to 30 Mbps)	
Video		1920 x 1200 @ 60Hz (100 m);	
Power Consumption		DC 5V 15 W	DC 5V 15W
Environment	Operating Temp.	0–50°C	
	Storage Temp	-20–60°C	
	Humidity	0–80% RH, Non-condensing	
Physical Properties	Housing	Metal	
	Weight	605 g	615 g
	Dimensions (L x W x H)	18.20 x 11.79 x 2.28 cm	

Limited Warranty

IN NO EVENT SHALL THE DIRECT VENDOR'S LIABILITY EXCEED THE PRICE PAID FOR THE PRODUCT FROM DIRECT, INDIRECT, SPECIAL, INCIDENTAL, OR CONSEQUENTIAL DAMAGES RESULTING FROM THE USE OF THE PRODUCT, DISK, OR ITS DOCUMENTATION.

The direct vendor makes no warranty or representation, expressed, implied, or statutory with respect to the contents or use of this documentation, and especially disclaims its quality, performance, merchantability, or fitness for any particular purpose.

The direct vendor also reserves the right to revise or update the device or documentation without obligation to notify any individual or entity of such revisions, or update. For further inquiries, please contact your direct vendor.